



Building Godly Leaders

**Official
Event
Rulebook**
*Updated for
2023 Convention*

Honesty and Integrity

Approach all events and activities
with the proper attitude.

Do your best.

Do not look for ways to stretch
or bend the rules. Your honesty and
integrity are more valuable
than silver and gold.

(Proverbs 22:1)

“Leaders tell but never teach
Until they practice
What they preach.”

- ***Featherstone***

Are You A Winner?

Every student who sets worthy goals is a winner.

Every student who starts excelling for the Lord is a winner.

Every student who studies the Bible is a winner.

Every student who memorizes Scripture is a winner.

Every student who learns the importance of serving others is a winner.

Every student who becomes a Self Starter is a winner.

Every student who stretches beyond their comfort zone is a winner.

Every student who becomes “Firmly Grounded” is a winner.

- ***Roy Johnson, Executive Director***

The L2L Official Event Rulebook provides fairness and consistency in convention, pre-convention and year-round events. They are in no way meant to take away from the autonomy of the local elderships to set forth the focus and direction of the local group.

5280 West Alabama Christian Drive

Montgomery, AL 36109

Phone: (334) 215-0251

Fax: (334) 215-0856

E-Mail: l2l@lads2leaders.com

Website: www.lads2leaders.com

©2022, L2L

Guidelines for Convention Attire & Behavior

As the annual L2L conventions quickly approach, our Executive Director, Roy Johnson, and the Board of Directors share in the excitement of all the students and adults who will be attending one of the eight conventions being held this year. It is our hope and prayer that this experience will be a positive one for attendees and that we will let our light shine on all those with whom we come in contact. To do this, we must be vigilant in how we present ourselves to the public and our fellow Christians by our actions, speech and dress.

As the general morality of the world continues to decline, we, as leaders in our homes and congregations, have a critical responsibility to set an example for those under our care. Children look to their family and congregational leaders for teaching and guidance in developing values that are in accordance with God's Word. The L2L Board of Directors and National Service Center staff are committed to establishing policies that will support this effort. The ultimate responsibility, however, rests with the leaders of each congregation to communicate standards of decency to those attending convention. These standards should be enforced by the parents and group leaders before convention to ensure appropriate behavior and dress are clearly understood by all. Problems in these areas at convention should be corrected by the group leaders and/or parents, if they are in attendance.

In order to reduce—and hopefully eliminate—any misunderstandings about what is expected of attendees, the following guidelines are provided:

1. Convention Attire: Short shorts or dresses, mini-skirts, revealing clothing, or shirts with unchristian messages or pictures should not be worn at any time. Leggings, tights, and yoga pants are not appropriate at any time unless the shirt/sweater over them comes to the knees.
2. Dress for Awards Ceremonies: Although Friday night's ceremony is considered more casual than Saturday night, there should be limits on "dressing down." Low-riding jeans or those with holes in them should not be worn. Hats/caps and flip-flops are also inappropriate. Slacks and shirts with collars should be encouraged. As for the girls, there should be no backless or strapless dresses or blouses. Clothing should not be too tight, too short, or too revealing. As a general guideline, Sunday worship clothing is appropriate for the Saturday night ceremony.
3. Dress appropriately for events: As an example, Speech and Song Leading require different clothing than Puppet Theater.
4. Overall Behavior: Reckless behavior anywhere in the hotel, convention center, or church building to include the halls, on escalators and elevators, or throwing items over balconies will not be tolerated. Also, respect for hotel and L2L officials is expected at all times.

The Board and National Service Center staff ask that congregational leaders, group leaders, parents, and chaperones work with us to ensure that our conventions are a safe and positive experience for everyone.

For the Board of Directors,



Roy Johnson
L2L Executive Director

To all adult volunteers:

Elders, deacons, preachers, group leaders, and parents...we are all role models. Our youth will not listen to what we say because they are too busy watching everything we do.

Are we telling them to read the Bible, but they never see us pick it up? Are we telling them to memorize scripture while we never do? When they look at the convention yearbook that lists our congregations, do they see our names listed under the Centurion of Scripture or Read the Word listings for our congregations? If not, do not be surprised if they refuse to do it as well.

If it really means anything to you, lead them by example...will they see your name in the convention yearbook this year?

In an effort to empower all of our adult volunteers to be better equipped to evaluate the progress of our young people and offer them constructive feedback, L2L has developed a series of training and judging videos for events like Speech, Song Leading, Songs of Praise, Debate and others. These videos are posted on our website, Youtube, and Vimeo. It is highly recommended that both youth and adults watch these videos. Examples of what to do and what not to do are included in these videos.

Important Information for Group Leaders

We want to recognize every participant who has worked hard and earned a particular award. Make sure they are registered for the correct events.

Things to do before the registration deadline:

- Collect verification forms and confirm in the registration system that the participant has earned the award. Forms DO NOT need to be mailed to the National Service Center. If a participant dropped out of an event or will not be able to complete the work, de-register them from that particular event **before registration closes**. The group leader should run reports from the L2L registration system and compare them to local records **before the registration deadline**. When registration closes, trophies, medals, and certificates are ordered, and names are printed on lists in the program.
- We count on YOU, the group leader, to use the honor system. It cheapens the work of others when awards are made for those who have not earned them, and they are called on stage.
- Ultimately, the responsibility is yours, at the local congregation. **Before registration closes, check on the progress of all participants.**
- For events that are separated by gender, this is determined by the student's gender at birth.

After registration closes:

- After registration closes it is extremely difficult, and sometimes impossible, to add people to events. Please ensure that registration is complete and accurate PRIOR TO the registration deadline.

In conclusion, we do not want to see a child disappointed because they did not get their award or confused because they got one that they did not earn. Help us make this a great experience for all participants.

The ABCs of L2L. Events in this rulebook will be marked with the letter corresponding to the list below to help you in planning events in which to participate.

A Action



Keepers & Providers	<input checked="" type="checkbox"/>
Jr. Leader	<input type="checkbox"/>
Good Samaritan	<input type="checkbox"/>
Sower	<input checked="" type="checkbox"/>
Bulletin Board	<input type="checkbox"/>
Scrapbook	<input type="checkbox"/>

B Bible

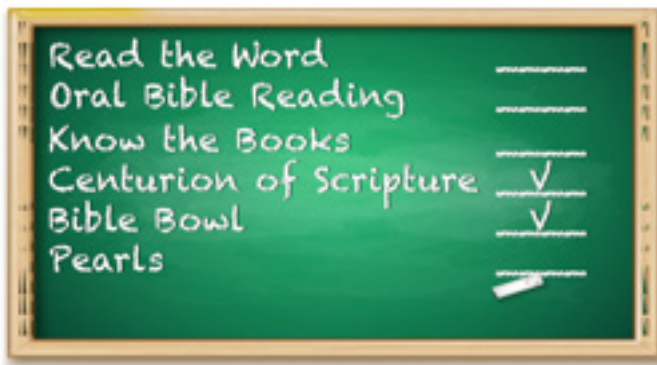

Read the Word	<input type="checkbox"/>
Oral Bible Reading	<input type="checkbox"/>
Know the Books	<input type="checkbox"/>
Centurion of Scripture	<input checked="" type="checkbox"/>
Bible Bowl	<input checked="" type="checkbox"/>
Pearls	<input type="checkbox"/>

C Communication



Speech	<input checked="" type="checkbox"/>
Debate	<input type="checkbox"/>
Song Leading	<input checked="" type="checkbox"/>
Art	<input type="checkbox"/>
Mass Communication	<input type="checkbox"/>
Puppets	<input type="checkbox"/>

Table of Contents

Event Rules

Red Coat Award	7
Year-Round Events	
Centurion of Scripture	10
Defender	11
GIFTS	12
GUARD	13
Good Samaritan	14
Headed to the Office	16
Junior Leader	17
Keepers	18
Know the Books	22
Providers	24
Read the Word	28
Second Language	29
Sower	31
Teach to Teach	33
Year-Round Bible Reading/Study	36
Year-Round Bulletin Board	37
Year-Round PowerPoint Presentation	38
Year-Round Puppet Theater	39
Year-Round Song Leading	40
Year-Round Songs of Praise	42
Year-Round Speech	44

Pre-Convention Events

Bible Bowl Individual Test	47
Mass Communications	48
Pearls	54

Convention Events

Art Says It	55
Art Says It (display only)	58
Banner	60
Bartimaeus	62
Bible Bowl Team	63
Bible Reading, Oral	65
Debate	66
Host/Hostess	70
Parade of Leaders	72
Puppet Theater	73
Scrapbook	79
Winners' Circle Scrapbook	82
Song Leading	83
Winners' Circle Song Leading	85
Songs of Praise	86
Winners' Circle Songs of Praise	88
Speech	89
Winners' Circle Speech	92

Entry Forms & Log Sheets

Art Says It Entry	96
Bible Reading, Year-Round	97
Centurion of Scripture Log	98
Centurion of Scripture Verification Form	99
GIFTS Verification Form	100
Good Samaritan Log	101
GUARD Verification Form	102
Junior Leader Verification Form	103
Puppet Theater, Year-Round Log	104
Scrapbook, Individual & Group Entry	105
Scrapbook, Winners' Circle Entry	106
Second Language Verification Form	107
Second Language Log	108
Sower Verification Form	109
Speech, Year-Round Final Checklist	110
Speech, Year-Round Log	111
Year-Round Song Leading Verification Form	112
Year-Round Songs of Praise Verification Form	113

Evaluation Forms

Art Says It	115
Banner	116
Bible Reading, Oral	117
Debate Score Sheet	118
Debate Summary Sheet	119
Mass Communications Blogging	120
Mass Communications Podcasting	121
Mass Communications PowerPoint Presentation	122
Mass Communications Storyline	123
Puppet Theater	124
Scrapbook	125
Scrapbook, Winners' Circle	126
Song Leading	127
Song Leading, Year-Round	128
Songs of Praise	129
Songs of Praise, Year-Round	130
Speech	131
Speech, Winners' Circle	132
Speech, Year-Round	133

When viewing this rulebook on a computer or other electronic device, each event name can be clicked or tapped to take you straight to that page. On each page, you can click or tap the page number at the bottom to return to this Contents Page. Web addresses in the rules for events may be clicked to open the respective websites.

RED COAT AWARD

Description

The Red Coat Award is the highest achievement available for youth in L2L. It represents many years of dedicated effort. It is strenuous but attainable. Few will earn the Red Coat, but those who do will have demonstrated service to God and others. The Red Coat is only awarded on the national level after the requirements have been met and certified by Roy Johnson and the L2L Board of Directors. This award is to honor Dr. Jack Zorn and his late wife, Frances Johnson Zorn.



The Story Behind L2L
Jack Zorn

Qualifications

- Must be in grade 7 or above to begin achieving the requirements. Accomplishments prior to grade 7 do not qualify.
- A minimum of four years to complete the requirements for the award, and then work on the Leadership Project will take up to another year. Must be a registered participant of L2L each year.
- Must submit the Red Coat Award Application to the L2L National Service Center.
- If all requirements have been met before graduation from high school, a student may submit a leadership project proposal.

- Most leadership projects are not approved as submitted, and extra requirements may be added to reach the level of this award. **Planning, organizing, and completing this project will take several months.**
- After the leadership project is completed, documentation must be submitted, such as: pictures, letters, videos, or a scrapbook. **All documentation must be received at the L2L Service Center by the registration closing date for that year.**
- An L2L Board of Review is held after completion of the project to determine if the L2L applicant's work toward the award is approved or not.

Requirements

Year-Round Events ~ Earn each of these required year-round events at least once:

- One Gold Centurion of Scripture; or 2 Silver Centurion of Scripture; or 3 Bronze Centurion of Scripture
- Gold Year-Round Speech or Song Leading/Songs of Praise
- Gold Know the Books
- Gold Good Samaritan
- Read the Word - Both the Old Testament and New Testament
- 3 Keepers or Providers Awards
- Sower or Defender

Pre-Convention Event Participation ~ One required each year:

- Mass Communications Blog (Formerly Article/Editorial through 2020) or PowerPoint
- Individual Bible Bowl or Pearls Test

Convention Event Participation ~ One required each year from each bullet point:

- Speech or Song Leading/Songs of Praise
- Debate or Bible Bowl Team

Electives ~ At least one per year—minimum of 4 different electives (Same event all four years will not count toward the award):

- Art Says It
- Puppet Theater
- Year-Round Bulletin Board
- Second Language
- Teach to Teach
- GIFTS
- GUARD
- Headed to the Office

Outreach Project ~ Required one time during the time of earning the award. Give a speech/sermon or lead songs at another congregation, youth event, gospel meeting, ladies' day, civic club, university, lectureship, etc., representing L2L. Documentation is required to include date, time, topic or song, and signed by a witness of the event.

Personal Growth Projects ~ Pick 2 and document to include date, time, topic, and signed by a witness of the event:

- Preach a sermon at a worship service or give a lesson at a ladies' event.
- Take a significant part in 3 home Bible studies.
- Participate in a door knocking campaign.
- Prepare food for 3 separate families with special circumstances, such as: funeral, sickness, new home, etc.
- Teach or co-teach a class at church for a quarter, or for VBS for at least three years during the time of earning the award.
- Participate in a mission trip and have an active role.
- Write and publish a 13-chapter Bible curriculum for use by an elementary/middle school Bible class.

After all of the listed requirements are completed, fill out the Red Coat Award application on the L2L website and submit it for review. You will also submit your Leadership Project proposal (described below) along with the application. Because of the time that is required for review, approval, and completion of the Leadership Project, it is recommended that the application and project proposal be submitted by convention of the year before you anticipate completing everything and receiving the award. This will allow for sufficient time to have the proposal reviewed, amended, and approved before starting. Applications and project proposals will be accepted through September each year for the following year's convention, but it is advised to submit everything earlier in order to have time to complete all work.

Leadership Project ~ All other requirements must be met prior to submitting or beginning the project:

- Project must benefit the local congregation or one of their outreach programs like evangelism or mission work.
- Project must demonstrate leadership by recruitment of a team, planning, supervising, and completing a meaningful project that requires a minimum of 40-60 hours of work. A leader must be able to recruit, motivate, and manage others.
- The project idea must be first approved by the local congregation and then submitted in writing to the L2L Red Coat Committee for approval. Most project proposals have to be amended in order to get approval. Examples of previous projects are available at the National Service Center. **Work on the project may begin only after approval is given.**
- Pictures and/or letters from the local congregation or others, a written report of the various stages of the project, and a summary of things learned must be submitted to L2L in booklet form. The written report and summary must be at least 4 pages, neatly typed in a business format. This may be submitted electronically.
- **A Board of Review** will be scheduled with L2L board members to talk with the applicant, review their accomplishments, and discuss their project.
- After this review, they will have earned the Red Coat Award or be notified of deficiencies.
- If there are questions at any time about the leadership project, or the Red Coat Award in general, please call the L2L National Service Center at 334-215-0251 to speak with someone.
- **The leadership project must be completed by close of convention registration in order to be awarded in that convention year.**

Ladder to Red Coat

Step 1 - Study the requirements and call the L2L Service Center if you have any questions

Step 2 - Complete all year-round and convention event requirements for Red Coat

Step 3 - Submit your Leadership Project proposal to the L2L Red Coat Committee for consideration

Step 4 - Receive approval in order to begin Leadership Project

Step 5 - Satisfactorily complete the Leadership Project with documentation

Step 6 - Board of Review will be held with applicant and Red Coat Committee

Award

Following review and approval by the Board of Review and an interview with the participants, a red blazer will be presented at the following year's convention to those who achieve all of the listed requirements and the Leadership Project. In addition to the red blazer, those who complete the requirements will receive the following:

1. Dinner with an L2L Board Member for the Red Coat Award recipient and parents
2. Red Coat certificate
3. Lifetime free convention registration
4. Name listed on the Red Coat Wall of Honor
5. Recognition in printed convention publications
6. Will be honored on stage each year at convention along with the new award recipients

Year- Round Event



Centurion of Scripture

This is a non-competitive event.

Purpose

To encourage memorization of God's Word. In Acts 10, a centurion commanded 100 soldiers. The Centurion of Scripture commands 100 Scriptures by memory. This is a local, year-round event where participants memorize scriptures.

Event Participation

1. Participation in this memory work event is open to all students and adults.
2. Qualifying students and adults attending the Convention must register as participants.
3. Qualifying students and adults not attending the Convention must remit the specified registration fee with their verification form and register as non-attending participants. Forms are to be turned in to the group leader.
4. All work must be completed prior to the convention registration deadline. At this time, awards are ordered based on registration. If a participant dropped out of this event or will not be able to complete the work, de-register them before registration closes.

Event Rules and Guidelines

1. A standard translation must be used.
2. Recitation is to be verbatim.
3. Student may select his/her own verses and may recite verses previously committed to memory. However, verses may not be used in consecutive years. For example, if a child has memorized the book of James as a second grader, he/she may memorize/recite it again as a fourth grader.
4. All work will be done at home during the year. The local program coordinator will appoint an adult to see that memory standards are met and verified on the form provided.
5. When reciting Scriptures, participants must turn in a log sheet to their group leader. Each local program should keep individual records of verses memorized in a log.
6. Log Sheets and Verification Forms to assist with record keeping can be found in the Entry Forms and Log Sheets section of this rulebook. **Group leaders are to electronically verify each participant of this event in the registration system.**

Awards

Awards for Centurion of Scripture will be given for four (4) levels of accomplishment. Students and adults may receive an award for each new set of 100 verses completed since last convention. Adults also have the option in the registration process to decline receiving an award if they desire. All names will still be included in the convention yearbook.

- *Bronze*: To all those who recite 100 verses in any number of sittings.
- *Silver*: To all those who recite 100 verses in two (2) sittings of fifty (50) verses.
- *Gold*: To all those who recite the entire 100 verses in one sitting.
- *Deca*: To all those memorizing 1,000 verses within 10 years or less.

Year- Round Event

Defender

This is a non-competitive event; one does this to learn the defense of their faith in the Bible and their love for Jesus Christ.

Purpose

The Defender event is designed to help young people understand the Christian's responsibility to always be ready to give a defense of the Christian faith.

What you will learn:

- Basic Christian evidence material that will gradually build throughout a four-year educational program.
- Defender has been designed with 13 chapters in order to be used during one quarter in a Bible Class setting. The short video format is also an excellent addition to the classroom setting.
- The four-year topics of Defender are as follows:
 - 1) Defending God
 - 2) Defending the Bible
 - 3) Defending Jesus
 - 4) Defending the Faith

Event Participation

1. Grades 6-12 may participate. Each year, the participant will read one book which is available for purchase through the L2L online store - <http://l2l.mybigcommerce.com/> The first book was made available for purchase in 2020. The second book will be available in the fall of 2021. Additionally, participants will watch video material that is required as part of the course. Videos are on the World Video Bible School site - www.video.wvbs.org/defenders - and corresponding names and numbers for videos are in each chapter at the point where they should be viewed.
2. A test will be administered based on the materials. If the participant scores 80% or higher, he/she will receive the medal for that year. When it is time for testing, a link will be placed on the L2L website.
3. The material should be completed in order but does not have to be done in consecutive years.
4. All four years are not a requirement to receive a medal. Medals for each year's participation will be given separately for each year completed.
5. In the third and fourth years of the program, the participant will be required to produce a video of their own addressing some topic of Christian Apologetics. These videos will be submitted to L2L for evaluation. The video judged to be the best for the year will be used as the next year's sample for the participants to watch, in order to see what is expected.

Awards

There will be a medal given at the annual convention for all participants who complete the requirements listed above.

Year- Round Event

GIFTS Girls in Fellowship & Team Study

This is a non-competitive event.

Purpose

To foster a spirit of cooperation and fellowship among Christian teen girls, and to develop a spiritual relationship and dependence on one another for strength to overcome temptation and serve faithfully. To grow in the ability to lead and participate in ladies' Bible classes.

Event Participation

Open to girls in grades 6-12. GIFTS is not recommended for girls younger than sixth grade. Books may be ordered from the National Service Center or by shopping in our online store.

Event Rules and Guidelines

1. The entire GIFTS book should be covered within the convention year. This study may be done in a Bible class, during home-school sessions, or other setting that suits the group. Classes may be done weekly in a girls-only Bible class on Sunday or Wednesday, or they may be weekly, bi-weekly, or monthly at someone's home on another day of the week.
2. Each study group must have at least one adult female mentor who is responsible for tracking the progress of each group member.
3. Sessions should begin and end with prayers led by group members. Prayer requests should be taken and honored at the time of the opening prayer.
4. Each session should cover a chapter in the GIFTS curriculum.
5. All members of the class should participate in the discussion. The mentor should be present to facilitate the discussion and answer any questions that may arise.
6. Six or more projects from the ends of the chapters must be chosen and completed by the girls within the year. The girls may all choose the same projects or may choose different ones.
7. Mentors should complete the GIFTS verification form (available in a later section of this rulebook) and sign it for submission to the Group Leader by the convention registration deadline date. The forms DO NOT need to be mailed to the National Service Center. **Group leaders are to electronically verify each participant of this event in the registration system.**

Awards

There will be recognition at the annual convention for all girls who complete the requirements listed above. Participant names will be listed in the convention yearbook.

Year- Round Event

GUARD Guys Understanding Authority & Real Discipleship

This is a non-competitive event.

Purpose

To foster a spirit of cooperation and fellowship among Christian teen boys, and to develop a spiritual relationship and dependence on one another for strength to overcome temptation and serve faithfully. To grow in the ability to lead and participate in Bible classes and worship services.

Event Participation

Open to boys in grades 6-12. GUARD is not recommended for boys younger than sixth grade. Books may be ordered from the National Service Center or by shopping in our online store.

Event Rules and Guidelines

1. The entire GUARD book should be covered within the convention year. This study may be done in a Bible class, during home-school sessions, or other setting that suits the group. Classes may be done weekly in a boys-only Bible class on Sunday or Wednesday, or they may be weekly, bi-weekly, or monthly at someone's home on another day of the week.
2. Each study group must have at least one adult male mentor who is responsible for tracking the progress of each group member.
3. Sessions should begin and end with prayers led by group members. Prayer requests should be taken and honored at the time of the opening prayer.
4. Each session should cover a chapter in the GUARD curriculum.
5. All members of the class should participate in the discussion. The mentor should be present to facilitate the discussion and answer any questions that may arise.
6. Six or more projects from the ends of the chapters must be chosen and completed by the boys within the year. The boys may all choose the same projects or may choose different ones.
7. Mentors should complete the GUARD verification form (available in a later section of this rulebook) and sign it for submission to the Group Leader by the convention registration deadline date. The forms DO NOT need to be mailed to the National Service Center. **Group leaders are to electronically verify each participant of this event in the registration system.**

Awards

There will be recognition at the annual convention for all boys who complete the requirements listed above. Participant names will be listed in the convention yearbook.

Year- Round Event



Good Samaritan

This is a non-competitive event.

Purpose

To reach out to others by going the extra mile. To teach the importance of showing people other than family the love of Jesus. This can be done by sending cards, visiting the sick and shut ins, conducting home Bible studies, performing service projects, etc. Being a Good Samaritan means going beyond our Christian living.

Event Participation

1. Both adults and students can participate. This is a project that can be done individually, by pairs, or by the youth group. The participants should encourage each other and work together (promoting cooperation), but the units are to be recorded on an individual basis. No one should go visiting alone. Students should not go out on their own without adult supervision or unless they are in a group. Family responsibilities are NOT considered Good Samaritan services. No points should be accumulated for this. Helping or serving members of the congregation, someone in the community, or someone in need is an example of Good Samaritan service. Remember, most people will send cards or visit their relatives. A Good Samaritan is not one that merely lives a Christian life, but one that serves by going the extra mile.
2. The local group leader (under the oversight of their eldership) has full discretion to decide the point system for their participants. The following is a sample list of projects that are all to be done in the name of Jesus:
 - Sending cards (store bought or electronic) to sick or shut-ins: 5 units for each card sent. Give extra points if the card is homemade.
 - Phone calls to those who are sick or shut in: 5 units for each call.
 - Visits to home, hospital, funeral home, or nursing home: 10 units for each visit.
 - Inviting visitors to church or youth activities: 10 units for each visitor per visit.
 - Conduct Bible studies: 50 units for each person at the study.
 - Participating in mission trips: 500 units per trip
 - Service projects: 10 units for each hour of service. Projects include, but are not limited to:
 - * Cutting grass for the elderly or handicapped.
 - * Cleaning the church building.
 - * Cleaning the house of an elderly or handicapped person.
 - * Serving at a fellowship dinner.
 - * Serving at a senior citizens' banquet.
 - * Helping the elderly or a mother with children.
 - * Working in a food pantry or clothing drive.
 - * Planting flowers in public places.
 - Any other deeds, approved by the local congregation, that benefit someone else without receiving any compensation in return and also glorify God.
3. Group leaders should monitor unit value based on projects. We are trying to encourage quality and meaningful projects. Group Leaders: DO NOT send log sheets to the National Service Center. **Group leaders are to electronically verify each participant of this event in the registration system prior to the convention registration deadline.**
4. Points are accumulated from registration deadline to registration deadline each year, not from convention to convention.

5. A sample form for record keeping is in a later section of this rulebook. Parental guidance is allowed in filling out the forms. ALL work must be completed prior to the convention registration deadline. If work is not completed, DO NOT register a person for this award, or deregister them if they were already registered.

****Verification forms/lists DO NOT have to be mailed to the National Service Center.****

Awards

1. Group leaders should stress that the joy of being a Good Samaritan is the greatest reward. Units and material awards are always secondary to the spiritual blessings of helping others.
2. Awards may be earned on three levels:
 - *Bronze*: 570 units
 - *Silver*: 1250 units
 - *Gold*: 2000 units
3. Only one award per participant each year. No multiple awards.
4. Participant names will be listed in the convention yearbook. Adults have the option to decline receiving an award but will still be listed in the yearbook.

Year- Round Event

Headed to the Office

This is a non-competitive event.

Purpose

To teach young men to grow into adult men of good character and reputation, and to instill in them the desire to become leaders in the Lord's church.

Event Participation

This event is open to young men in grades 6-12.

Requirements

Students must participate in a class at their home congregation, preferably taught by one or more of the elders. During the class or after completion, the students will choose six or more goals from the back of the Headed to the Office book to work toward for the year. The goals must be completed by the posted convention registration deadline for the current convention year. The timing for this event is convention registration deadline to convention registration deadline each year. Books may be ordered by calling the National Service Center or by shopping in our online store.

Group leaders are to electronically verify each participant of this event in the registration system prior to the convention registration deadline. ALL work must be completed prior to the convention registration deadline. If work is not completed, DO NOT register a person for this award, or de-register them if they were already registered.

Awards

There will be recognition at the annual convention for all boys who complete the requirements listed above. Participant names will be listed in the convention yearbook.

Year- Round Event



Junior Leader

This is a non-competitive event.

Purpose

To instill basic leadership skills in young participants. Participants study the leadership qualities and characteristics of many leaders from the Bible. Participants will complete practical projects that will benefit the local congregation and community.

Event Participation

Open to boys and girls from grades K-5, this material can be taught in Bible class, home school or other group sessions. Participants do not have to attend convention to participate in this non-competitive event. Participation in this study is on a local level. While this is not a convention event, participants who earn awards will have their names listed in the convention yearbook. A digital version of the yearbook will be posted to the L2L website and will be available as a free download in the L2L online store.

Event Rules and Guidelines

1. These rules apply to all present and future versions of Junior Leader.
2. The participant may progressively participate from year to year until they are above a 5th grade level or until they have achieved all three levels of Junior Leader.
3. Levels and requirements are as follows:
 - Level I: Complete chapters 1-4 in the Junior Leader book and complete one project per chapter for a total of 4 projects.
 - Level II: Complete chapters 5-8 in the Junior Leader book and complete one project per chapter for a total of 4 projects.
 - Level III: Complete chapters 9-13 in the Junior Leader book and complete one project per chapter for a total of 5 projects.
4. There are two levels of projects. Servant level indicates projects that are easier to complete and are suitable for those who are younger. Skilled level indicates projects that are more challenging for this age group and are for those who are older. It will be the prerogative of the adult mentor and/or church leadership to determine which level projects a student should complete.
5. Games, activities, and crafts will be rated either servant or skilled for the benefit of the adult mentor in choosing activities appropriate for the class.

Awards

Junior Leader Level I, II, and III certificates are available as a free download through the online store on the L2L website. The adult mentor will present the certificates as participants complete the different levels of the event. Upon completion of Junior Leader Level III, a final award may be requested by the adult mentor for presentation to the participants(s) on the local level.

Group Leaders: Verification forms (available in a later section of this rulebook or in the Junior Leader book) for each participant should be completed and kept in each student's file. There is no official deadline for completion of Junior Leader. However, if you would like the names of the children who have completed Junior Leader to be included in the convention yearbook, then they will need to be registered in the online registration system by the posted registration deadline.

Year- Round Event



Keepers

This is a non-competitive event.

GOAL

Keepers is a non-competitive, year-round event that can be earned each year by girls in grades 3-12. Male participants involved in the Providers event may choose one of these categories in which to participate each year.

PURPOSE

To foster practical homemaking skills. The name is taken from young women as described in Titus 2:4-5, particularly “keepers at home.” The program will provide experience in practical homemaking skills that will be valuable to all Christian girls and women including those who work, at any point, outside the home. Each event within the program will serve to encourage a specific skill that will help prepare girls for their most basic and Biblical place as adults; that is, their place in the home as wives and mothers. The program will use Proverbs 31, the virtuous woman, for the various categories of skills taught.

More information on this event and others, check out the videos on our website here - <https://www.lads2leaders.com/training-videos>

AWARDS

Girls in grades 3-12 can earn up to three different awards annually. Except as indicated below, the individual awards may be earned only once in a young woman’s L2L career. The exceptions to this are the Sewing, Cooking, and Hospitality awards, which may be earned up to three times each. **Girls may also choose as one of their three categories one of the categories from the Providers event which is detailed later in this rulebook.** For each award earned during the year, a girl will receive a specialized award. The participant’s name will be listed in the convention yearbook, and she will be recognized at convention during the year-round events portion of the ceremony.

Group leaders are to electronically verify each participant of this event in the registration system prior to the convention registration deadline. ALL work must be completed prior to the convention registration deadline. If work is not completed, DO NOT register a person for this award, or deregister them if they were already registered.

EVENT CATEGORIES

1. **Cooking: “...she provides food for her household.”**

- a. Recipe Book: The student will distribute index cards or recipe cards to the ladies in her home congregation either in person or by email, soliciting favorite recipes and assemble these into a well-organized recipe box, book, or recipe e-book containing at least 100 recipes (total) and at least five recipes in each of the following categories: appetizers, breads, soups, main dishes, side dishes, fruits, desserts, and beverages. The book will be approved by a Keepers mentor in the local church. These might be widely used by posting on the church website.
- b. A mentor will conduct a session in which she demonstrates the use of kitchen equipment (coffee maker, food processor, mixer, dishwasher, etc.). Each student must attend.
- c. Meal Plan and Cooking: The student will plan and prepare a well-balanced meal for her family or for another family in the congregation. She will also follow up with all clean-up chores following the meal preparation. She will document this meal, and it must be approved by a Keepers mentor.

2. **Food Preservation: “...she brings her food from afar.”**

The student will obtain a fresh fruit or vegetable and successfully preserve at least five jars or five freezer packages of this commodity for later use. The student will share at least one package or jar with a widow or widower in the congregation. This work will be documented by a Keepers mentor. This project may be done in a group with a men-

tor, but each student is responsible for her own five jars/packages.

3. Table Setting: “...she looks well to the ways of her household.”

The Keepers participants and a mentor will meet around a table, and the mentor will instruct the students in the proper setting of both a formal and a casual table setting, including centerpiece (silverware, plates, bowls, napkins (folding), glasses, etc.). Each girl will be responsible for duplicating this table setting at the meeting and then duplicating it at home for her family or in some home for some family at a regular meal time. Attendance at the demonstration and the duplication must be documented by a mentor.

4. Information Resources: “she opens her mouth with wisdom.”

Each student will collect and organize (or locate) a minimum of twenty books (digital and/or hardcopy) including recipe books, literary classics, Bible resource books, and children’s literature. This collection of resources must be seen and approved by a Keepers mentor. This “library” will be used at least once during the year in (a) entertaining young children without pay while their parents are working in a church-related activity or (b) conducting a Bible study with a non-Christian or a new Christian.

5. Nutrition and Health: “...she does him good and not harm all the days of her life.”

- a. Mentors will invite a health professional (preferably a dietician) to meet with the girls and discuss the importance of proper nutrition. He/She will also cover the warning signs of diseases related to nutrition as well as eating disorders. All girls who are working on this award must be present.
- b. Mentors will devise an exercise program for the Keepers participants. This can be done as a class or individually, but must include at least thirty minutes of physical exercise, three times a week for a minimum of six weeks.

6. Sewing: “She seeks wool and flax.”

This category is broad and allows for much creativity. Thus, in this category girls may receive the sewing award by completing any two of the listed projects. Girls may receive additional sewing awards in additional years by completing two different projects in another year. Therefore it would be possible to receive three sewing awards in three different years.

- a. Basic construction: a student begins with a piece of fabric and a pattern and completes any garment. This can be something as simple as an apron or as complicated as a wedding dress, but it does have to require a pattern and fabric. Project ideas and finished products must be approved by a mentor.
- b. Hand Embroidery: Any two different completed designs on any fabric. Must be approved by a a mentor. This can be silk ribbon embroidery, shadow embroidery, counted cross stitch, candlewicking, smocking or two of many other kinds of embroidery. It may be done on purchased dish cloths, burp cloths, dresses, handkerchiefs, t-shirts or any other finished or unfinished piece of fabric. When the mentor approves this, though, the two pieces should be finished, so that they could be given as gifts.
- c. Mending: This project must include five mended articles of clothing approved by a mentor. Ideas: replacing missing buttons, repairing a hemline, sewing a ripped garment, patching a hole or repairing a loose pocket.
- d. Quilting: Individual completion of a baby quilt, any type of construction, either hand or machine quilted. Can also be a full-sized quilt and accomplished as a group, but each girl must have played a significant part in both construction and quilting.
- e. Sewing for the home: Individual completion of a simple pair of curtains, a table runner, a set of napkins, a set of placemats, a table cloth, a set of pillowcases, or a decorative flag. Projects must be approved by a mentor.
- f. Sewing for missions: This is a group project in which a mentor instructs the girls as they make a minimum of a dozen “pillowcase dresses” or aprons. These are to be sent to a foreign mission spot where cute clothing is not easily accessible. The instructions for aprons and pillowcase dresses can easily be found online.

7. Ironing: “She dresses herself with strength and makes her arms strong.”

A mentor teaches a student to properly iron a variety of items (e.g., a woman’s skirt/pants, a men’s dress shirt and a tablecloth).

8. Laundry: “She is not afraid of the snow ...for all her household are clothed in scarlet.”

A mentor will conduct a “laundry class” in which she teaches sorting, washing (all types and settings) and drying.

She will teach the reading of clothing labels. This will include both “regular” loads, delicate garments and hand-washables. The class should also cover things like stain removal and fabric softeners. Students will satisfactorily do the laundry at home for a month to achieve the award. A mentor will approve.

9. Cleaning: “She works willingly with her hands.”

A mentor will conduct a hands-on class about cleaning house. This can be done in several ways. The mentor may choose to have all the girls over and teach them as they clean her own house. The instructions should include dusting furniture, vacuuming hard floors and/or carpet, mopping, sweeping, kitchen countertop cleaning, oven cleaning, and bathroom cleaning. The “class” should be thorough. Then each girl should be “placed” in a home of the congregation...(that of a widow, a shut-in, an elderly person, or a family under duress) to go at an appointed time and clean house (an apartment qualifies, but not a single room, as in a nursing home room.) This should be done in a thorough fashion as if each girl had been hired for this duty, but no pay should be accepted.

10. Childcare: “her children also arise and call her blessed.”

Each girl should complete a course in child care--either a class offered by a baby-sitting organization, a local school, or a mentor in the congregation. No official certification is required for this award, although it is encouraged. Then each award candidate must complete ten hours of baby-sitting during the year. A mentor must verify.

11. Horticulture: “...with the fruit of her hands she plants a vineyard.”

Under the supervision of a mentor, students must plant and maintain a garden (either vegetable or ornamental) for a minimum of a three month period during the year. The garden should contain at least two variations of plants and should total at least ten plants. The garden can be an indoor garden in areas where students live in apartments. The mentor should see the garden when first planted and at least once again toward the end of the three month period. The garden should be free of weeds and protected from blight or weather damage. The student will develop a document describing her planting zone, plant requirements, soil used, etc.

12. Home Safety: “She does him good, and not harm, all the days of her life.”

Under the supervision of a mentor, a student must assemble all items needed for a household first aid kit. The student should be able to tell the mentor how each item is used in case of an emergency. The kit should be placed in an accessible place in the student’s home. The following is a suggested list taken from the official Red Cross website www.redcross.org.

- 2 absorbent compress dressings (5 x 9 inches)
- 25 adhesive bandages (assorted sizes)
- 1 adhesive cloth tape (10 yards x 1 inch)
- 5 antibiotic ointment packets (approximately 1 gram)
- 5 antiseptic wipe packets
- 2 packets of aspirin (81 mg each)
- 1 blanket (space blanket)
- 1 breathing barrier (with one-way valve)
- 1 instant cold compress
- 2 pair of non-latex gloves (size: large)
- 2 hydrocortisone ointment packets (approximately 1 gram each)
- Scissors
- 1 roller bandage (3 inches wide)
- 1 roller bandage (4 inches wide)
- 5 sterile gauze pads (3 x 3 inches)
- 5 sterile gauze pads (4 x 4 inches)
- Oral thermometer (non-mercury/non-glass)
- 2 triangular bandages
- Tweezers
- First aid instruction booklet

Along with this assembly, this award includes a class, attended by all students, in which a qualified person will teach the girls how to properly treat injuries including a sprained ankle, a minor burn, a bee sting, a minor cut, a skinned knee, a wood splinter under the skin, a bump on the head, and an abrasion or small object in the eye.

13. Money Management: “...he will have no lack of gain.”

- a. Students attend a coupon class and clip coupons from the newspaper and from web sources for a month. These should be used with the help of parents/mentors during the shopping/dining, etc., during that month, and the student should keep records of money saved by using the coupons. This record should be turned in to the mentor.
- b. A mentor should help each student draw up a monthly sample budget for a newly married couple in the present economy. This monthly budget plan should include all necessary expenditures. Mentors should be sure that church contribution is budgeted first, then necessities and discretionary allotments. Students should be able, upon completion, to see approximately what it would cost at the present time to begin a home.

14. Hospitality: “She opens her hand to the poor and reaches out her hands to the needy.”

The student will choose one of the following activities and document its completion with a mentor. This activity must be done by the student and must be in the home of the student. Students may complete up to three of these projects, one per year.

- a. A student will prepare a meal in her home for a person in need, a widow, an elderly person, a missionary, or a non-Christian friend. She may choose to bring the meal to the person or feed them in her home.
- b. If feasible, a student will prepare a place of lodging in her home for a visiting minister, missionary, or a Christian traveling through the area.
- c. A student will host a youth devotional and/or game night in her home and prepare all refreshments.
- d. A student will work with the deacon in charge of benevolence to collect food items which will be given to people in and out of the church in need of basic necessities.

15. Basic child discipline: “She watches over the ways of her household.”

- a. Attend a class (the mentor can decide the length and number of sessions) taught by a proven, competent family woman on “A good mother’s discipline of her children.” Subjects should include:
 - When a child does wrong: when it’s appropriate to merely explain, when to scold, when to spank.
 - Limits to spanking to avoid abuse.
 - In what ways were your children different in reference to what kinds of discipline were effective?
 - What are some different kinds of discipline you used to rear your children (in accordance with God’s teaching)?
- b. Write a 1-2 page essay describing a punishment you received that you believe has helped you be a better, stronger young woman.
- c. Meet with a wise, elderly person in your congregation and write a brief summary of his/her answers to these questions:
 - In what ways were your children different in reference to what kinds of discipline were effective?
 - What are some different kinds of discipline you used to rear your children right?
 - If you could go back to your children’s early life with you, how would your discipline be different?

Year- Round Event



Know the Books

This is a non-competitive event.

Purpose

To teach the books of the Bible and their themes.

Participants

- Level One: Children through grade 2
- Level Two: Grade 3 - Adult
- Level Three: PreK - Adult

Requirements for:

- Level One: recite or sing the books of the Bible in order.
- Level Two: recite the books of the Bible in order.
- Level Three: recite the books of the Bible, along with their themes, in order.

Note: Adding themes makes this level a greater challenge. A list of suggested themes for each book is on the next page.

This event will be completed in the home congregation and **group leaders are to electronically verify each participant of this event in the registration system.** DO NOT register for this event if the work is not completed by the registration deadline. Awards will be provided to the group leaders in the registration packets at convention. Participants will be recognized during the Friday evening awards ceremony. Awards for all three levels should be presented at the local awards ceremony after convention. Participant names will be listed in the convention yearbook.

****Verification forms/lists DO NOT have to be mailed to the National Service Center.****

Award Levels:

- *Bronze*: for reciting the New Testament books.
- *Silver*: for reciting the Old Testament books.
- *Gold*: for reciting both the Old and New Testament books.

Suggested Themes for Know the Books

Old Testament

1. Genesis – the beginning
2. Exodus – the leaving
3. Leviticus – worship laws
4. Numbers – sin and God’s mercy
5. Deuteronomy – review of the law
6. Joshua – the promised land
7. Judges – Israel tested and delivered
8. Ruth – loyalty
9. 1 Samuel – from judges to kings.
10. 2 Samuel – David’s reign
11. 1 Kings – Solomon and the divided kingdom
12. 2 Kings – the divided kingdom to captivity
13. 1 Chronicles – the reign of David
14. 2 Chronicles – Solomon and other kings of Judah
15. Ezra – remnant returns
16. Nehemiah – rebuilding the walls of Jerusalem
17. Esther – God’s providence
18. Job – pain and suffering
19. Psalms – worship
20. Proverbs – wisdom
21. Ecclesiastes – material goals are empty
22. Song of Solomon – beauty of marital love
23. Isaiah – the prophet of God’s rule
24. Jeremiah – the prophet of failure
25. Lamentations – Jeremiah’s sorrow
26. Ezekiel – the prophet of hope
27. Daniel – the prophet of dreams
28. Hosea – spiritual adultery
29. Joel – day of the Lord
30. Amos – seek the Lord and live
31. Obadiah – God punishes Edom
32. Jonah – God loves the Gentiles
33. Micah – consequences of sin
34. Nahum – Nineveh’s downfall
35. Habakkuk – the just live by faith
36. Zephaniah – God’s goodness and severity
37. Haggai – build the Lord’s house
38. Zechariah – judgment and encouragement
39. Malachi – God’s people rebuked

New Testament

1. Matthew – Jesus, the King
2. Mark – Jesus, the servant
3. Luke – Jesus, the man
4. John – Jesus, the Word of God
5. Acts – the Church
6. Romans – righteousness revealed
7. 1 Corinthians – Church problems
8. 2 Corinthians – be reconciled to God
9. Galatians – Christian liberty
10. Ephesians – Christ and His Church
11. Philippians – rejoice in the Lord
12. Colossians – the pre-eminence of Christ
13. 1 Thessalonians – the 2nd coming of Christ
14. 2 Thessalonians – the day of the Lord
15. 1 Timothy – order in the Church
16. 2 Timothy – the true minister of Christ
17. Titus – believer’s Godly life
18. Philemon – treatment of a brother
19. Hebrews – better
20. James – true faith produces works
21. 1 Peter – comfort for the suffering Christians
22. 2 Peter – warnings against false teachers
23. 1 John – Christ and fellowship with God
24. 2 John – warnings against deceivers
25. 3 John – receive true believers
26. Jude – contending for the faith
27. Revelation – victory

Year- Round Event



Providers

This is a non-competitive event.

Goal

Providers is a non-competitive, year-round event that can be earned each year by male participants in grades 3-12. Female participants involved in the Keepers event may also choose one of these categories in which to participate each year.

Purpose

To foster practical skills in typical areas of heading and maintaining a home and family.

Each category within the event will serve to encourage a specific skill that will help prepare male participants for their most basic and Biblical place as adults; that is, leading their homes as husbands and fathers. The event will also provide experience in practical home maintenance skills that will be valuable to all Christian male participants.

More information on this event and others, check out the videos on our website here - <https://www.lads2leaders.com/training-videos>

Awards

Male participants in grades 3-12 can earn as many as three different awards annually. Unless otherwise indicated, the individual awards may be earned only once in a participant's L2L career. Each participant will receive an award for each of the categories chosen. The participant's name will be listed in the convention yearbook, and he will be recognized at Convention during the year-round events portion of the ceremony. **Boys may also choose a category from the Keepers event to count as one of their three categories.**

Group leaders are to electronically verify each participant of this event in the registration system prior to the convention registration deadline. ALL work must be completed prior to the convention registration deadline. If work is not completed, DO NOT register a person for this award, or deregister them if they were already registered.

Ideas for Carrying it out

Participants should consult mentors when choosing and planning specific challenges in a given category to get the award. Mentors are encouraged to seek the guidance or actual participation of experts. For example, a visit to talk with a kind-hearted banker might be good for finances and the wisest men to mentor the family governance matters.

For those activities which involve some risk, mentors should either secure parental participation or obtain written parental consent. The local church leadership should be careful to only choose the most responsible and trained (certified where appropriate and possible) men to mentor the potentially dangerous challenges. All mentors should carefully review safety and operations manuals for power tools and potentially dangerous equipment and present them to the participants to review. These requirements are intended to ensure that participants are taught the need for caution and safety when working with potentially volatile, hazardous, or dangerous equipment and repairs.

Local church leaders should follow youth protection guidelines concerning mentoring. In order to protect the welfare of youth and the good name of mentors, avoid any private contact between youth and mentors. Mentoring

should always be done in public.

Where inexpensive tools are necessary to do the challenges, parents (or others) are encouraged to fund the purchases so each participant can start his own tool collection. This will contribute to the retention of what he has learned.

Event Categories

For each category listed below, participant will complete all of the items listed and have them approved by a mentor. Make special note of the categories that require adult/parental supervision.

1. Spiritual leadership of my family. *Looking forward to when you are a father:*

- a. Make a “daddy list” of 25 things you want to make sure your children know.
- b. Make a list of 15 things you will do as a dad, taking the lead as spiritual leader.
- c. Make a list of 10 creative ideas for an enjoyable, educational Bible time with your children.
- d. Direct a family Bible time for your family once each night for seven days.

2. Basic marriage.

- a. Attend a class (the mentor can decide the length and number of sessions) taught by a proven, competent family man on “How to love a wife.” Subjects will include things such as kindness, forgiveness, thoughtfulness, helping with housework, etc.
- b. Go to ten Christian wives and ask, “In the last two weeks, what is the nicest thing your husband did for you?” Meet with your mentor and others who are doing Providers and discuss what you’ve learned from the survey.
- c. Memorize and quote to your mentor: 1 Timothy 3:4-5, Ephesians 5:25-28.

3. Basic child discipline.

- a. Attend a class (the mentor can decide the length and number of sessions) taught by a proven, competent family man on “A good father’s discipline of his children.” Subjects should include:
 - When a child does wrong: when it’s appropriate to merely explain, when to scold, when to spank.
 - Limits to spanking to avoid abuse.
 - In what ways were your children different in reference to what kinds of discipline were effective?
 - What are some different kinds of discipline you used to rear your children (in accordance with God’s teaching)?
- b. Write a 1-2 page essay describing a punishment you received that you believe has helped you be a better, stronger man.
- c. Meet with a wise, elderly person in your congregation and write a brief summary of his/her answers to these questions:
 - In what ways were your children different in reference to what kinds of discipline were effective?
 - What are some different kinds of discipline you used to rear your children right?
 - If you could go back to your children’s early life with you, how would your discipline be different?

4. Lawn mower use and maintenance.

- a. Observe/participate in changing the oil and filter in a push mower or a riding mower.
- b. Demonstrate understanding of how to select proper height for blades on a lawn mower.
- c. Observe/participate in removal/changing/sharpening lawn mower blades.
- d. Demonstrate understanding of how and when to use fuel additives in a lawn mower, the differences between additives for lubrication and those which are for preserving fuel quality.
- e. Observe/participate in the skillful use of a weed eater, including how to replace the cutting line.
- f. Each student must volunteer to mow a widow’s lawn once without pay.
- g. Review the operations and safety manual for a lawn mower.

5. Basic plumbing.

- a. Learn how to turn off the water source at your house (where applicable).
- b. Observe/participate in the installation of a toilet kit.
- c. Observe/participate in the repair of a leaky, basic faucet.
- d. Observe/participate in cleaning a bathroom drain and re-aligning the stopper properly.
- e. Observe/participate in gluing four short pieces of PVC with joints.
- f. Students who are 14 and over are also required to observe/participate in “sweating” copper. Students must successfully solder three copper joints.
- g. Review a basic safety manual about performing simple household plumbing repairs.

6. Basic carpentry.

- a. All students must observe/participate in:
 - Fixing a squeaking hinge
 - Installing an interior door handle
 - Properly gluing and clamping a wood joint
 - In the basics of 2x4 framing: What it means to “transfer weight to the ground” and why it is important in house framing. They must also understand the meaning of “load bearing wall.”
- b. Participants who are 14 and over are also required to:
 - Learn how to safely use a circular saw, a drill, a hammer, a table saw, and a band saw. This includes reviewing a basic safety manual about working with these tools.
 - How to correctly set a post in concrete for a fence or mailbox.
 - Replace a window pane (an old, discarded window can be used for this challenge).
 - Replace a fiberglass shingle.

7. Basic painting.

- a. All students must:
 - Understand basic brush variations (width, angle vs. straight, bristles, etc.)
 - Understand priming and use of oil-based versus water-based paint
 - Observe/participate in the correct use of masking tape for painting, caulking, and in general wall preparation
 - Help an adult paint at least one wall.
- b. Participants 14 and over must also learn to use a home paint sprayer and how to properly “cut in” around moldings and trim with an angle brush.

8. Basic electrical.

- a. Develop an understanding of electrical power coming into the breaker box and then being fed throughout the house. Learn how to shut the power off on their own house (where applicable).
- b. Observe/participate in replacing a simple light switch and an outlet. Student must remove a switch or outlet from a wall, and install a new one successfully.
- c. Develop familiarity with an instrument for checking whether or not current is flowing into an outlet.
- d. Review a basic safety manual about performing simple household electrical repairs.

9. Basic family finances.

- a. Create a basic, sample family budget beginning with total income, then various typical expenses. Contribution to the Lord’s church should be at the top of expenditures.
- b. Balance a “practice” checking account.
- c. Engage in the imaginary process of:
 - Buying/financing a car from a dealer.
 - Buying a house. Understand the correlation between your credit scores and your interest rate.
 - Renting an apartment.
 - Selling a used car in your yard (Title, bill of sale, safe manner of payment, etc.).

- d. Learn basic family finance issues.
 - How to set up and maintain checking and savings accounts.
 - How mutual funds, stock market, IRA's work.
 - How risk in investments relates to potential growth.
 - Basic understanding of various, typical taxes for a family (Federal, State, property, sales, etc.).
 - Basic understanding of how to control/manage credit: loans, credit cards.

10. Basic car maintenance. (Widows could pay for materials and bring their cars to benefit from these lessons.)

- a. Observe/participate in changing the oil and filter in an automobile.
- b. Observe/participate in changing an air filter in an automobile.
- c. Find the proper tire pressure for a particular automobile, check the pressure and add/subtract air where necessary (Perhaps participants would be required to bring their own tire gauge).
- d. Wash and wax a car properly.
- e. Review a basic manual about auto maintenance and simple repairs.

11. Basic gardening.

- a. From a skilled gardener, learn:
 - When to plant.
 - How to properly prepare your soil. Learn unique qualities of the soil in your area and what fertilizers are commonly used.
 - The unique ways potatoes are planted, hills of squash are planted, onions are planted, trees are planted, etc.
- b. Plant a garden. For those students living where a traditional garden isn't possible, planting various vegetables in pots is an acceptable garden. Your mentor must visit your garden on planting day, sometime during the growing season, and at harvest time.
- c. Provide at least two vegetables for your family's meal one evening from your harvest.

12. Basic home security.

- a. Go with your mentor to a store which sells burglar alarm systems and get a basic understanding of how the most common ones work.
 - How are they installed? Can an average homeowner do it himself?
 - Will they operate on batteries if the electricity goes out?
 - How are their alarms triggered?
 - Make a good plan for remembering to replace batteries in smoke/carbon monoxide alarms (for example, replace them each year on the birthday of the head of the household).
- b. Learn the fundamentals of smoke alarms.
 - What kinds of alarms are available.
 - The ideal placement in the home.
 - How many are needed in a home.
 - Cost.
 - Maintenance required.
- c. Learn gun use and safety (This should never be done without adult supervision and written parental approval). If a highly-trained mentor is not available within the local congregation, it would be wise to arrange for formal training with a certified professional.
 - Good safety habits. How to safely store guns.
 - How to safely and properly clean a gun.
 - How to properly hold a gun when shooting.
 - How to properly use sights.
 - Gun laws in your given area. What to look for in a good place for target shooting.

Year- Round Event



Read the Word

This is a non-competitive event.

Purpose

To encourage students and adults to read the Scriptures. This is a local, year-round event where participants read their Bibles.

Event Participation

1. Participation is open to all students and adults.
2. Church leaders, parents and all adults should be encouraged to participate to set the proper example for our youth and to grow spiritually. Being a New Testament church, we need to read the Word.
3. Students and adults participating in this event must register as participants.

Event Rules and Guidelines

1. To qualify, the student or adult must read either the entire New Testament or entire Old Testament prior to the convention registration deadline. Of course, it is encouraged for participants to read through the entire Bible each year, but only one award for participation will be presented.
2. The reading may be from any standard translation - not a paraphrase. Seek advice from your church leadership regarding various standard translations.
3. Individuals may listen to audio tapes, CDs, or electronic devices to qualify.
4. All reading must be done within a 12-month period or less and must be done prior to the convention registration deadline. Do not register for this event if the work is not completed by the registration deadline.

Group leaders are to electronically verify each participant of this event in the registration system.

****Verification forms/lists DO NOT have to be mailed to the National Service Center.****

Awards

Awards will be given to those who meet the requirements.

Year- Round Event

Second Language

This is a non-competitive event.

Purpose

To promote and increase the ability of men and women to be able to communicate basic information and also to teach the gospel of Jesus Christ in a second language and/or sign language.

Event Participation

1. Participation is open to all students and adults. This is not a convention event. Participants demonstrate these skills at a local level.
2. Participants may begin work at any time on this event.
3. Participants are allowed to advance one award level per year. The Bronze award must first be obtained before completion of the Silver award, and completion of both Bronze and Silver is necessary to be eligible to complete the Gold level award. The Bronze and Silver levels are preparation level awards. A participant may complete these awards by communicating the assigned tasks to any individual, not necessarily someone who does not speak English. The Gold level is an application level award. In order to be eligible for this award, the participant **MUST** complete the assigned tasks in communication with someone who does not speak English or uses sign language. The participant's name will be listed in the convention yearbook.
4. Multiple awards may be earned in a convention year. For example, a person may complete the Bronze level in both sign language and Spanish, or both French and German. The participant must be registered for this event before the convention registration deadline. **Group leaders are to electronically verify each participant of this event in the registration system.**

****Verification forms/lists DO NOT have to be mailed to the National Service Center.****

Event Rules and Guidelines

1. **BRONZE LEVEL** (Preparation Level) The participant is able to clearly communicate both section one and section two of the following to another person or persons, using a language other than their own or by using sign language. As stated above, this communication can be given to any individual, and this individual can be someone who speaks English.

SECTION ONE

Learn to say the following phrases fluently in another language by memorization of the phrases:

- Hello, my name is _____.
- Jesus loves you.
- What is your name?
- Do you need help?
- I am from _____.
- Are you hurt?
- Where is your home?
- I love you.
- Where is your father or mother?
- The Bible is the Word of God.

SECTION TWO

Learn to say the following scriptures in another language fluently by memorization of the verses:

- Genesis 1:1
- John 3:16
- John 14:6
- Acts 2:38
- Matthew 28:18-20
- Ecclesiastes 12:13
- 1 Timothy 3:15

2. **SILVER LEVEL** (Advanced Preparation Level) The participant is able to clearly communicate both section one and section two of the following to another person or persons, using a language other than their own or by using sign language. As stated above, this communication can be given to any individual, and this individual can be someone who speaks English.

SECTION ONE

Achieve the bronze level award during a previous convention year.

SECTION TWO

Learn to say the following scriptures in another language fluently by memorization of the verses for the purpose of teaching the gospel of Jesus Christ:

- Romans 3:23
- Romans 6:4-5
- Romans 10:9-10
- Hebrews 1:1-2
- Acts 17:30
- James 2:18-20
- Mark 16:15-16
- John 3:5
- Acts 22:16
- John 14:1-3
- Ephesians 4:4-6

3. **GOLD LEVEL** (Application Level) The participant is able to clearly communicate both section one and section two of the following to another person or persons who does not speak English, using a language other than their own or by using sign language. As stated above, this communication **MUST** be someone who does not speak English or who uses sign language and is an application level award.

SECTION ONE

Achieve the silver level award during a previous convention year.

SECTION TWO

Complete two of the following:

1. Participate in a mission trip by using second language and/or sign language skills. A log of this communication should be kept and approved by local congregation representative.
2. Sign or interpret at a local church service, church event, or Bible class at least six times in a period of one year. A log of completion should be kept and approved by local congregation representative.
3. Teach the gospel to someone using second language and/or sign language skills. A log of completion should be kept and approved by local congregation representative.
4. Teach a Bible story to children using second language and/or sign language skills at a VBS, Bible class, or in a mission field setting at least six times. A log of completion should be kept and approved by local congregation representative.

Completion Guidelines

1. A participant's progress shall be monitored by someone selected by the local church leadership as one demonstrating ability, experience, and expertise in the chosen language or sign language.
2. The local church leadership will evaluate and acknowledge when the participant has successfully completed the various awards. Log Sheets and Verification Forms to assist with record keeping can be found in a later section of this rulebook. Group leaders are to electronically verify each participant of this event in the registration system.

Awards

Qualified participants will be recognized at convention. Participant names will be listed in the convention yearbook.

Year- Round Event



Sower

This is a non-competitive event.

Purpose

To learn the skill of approaching others to ask for a personal Bible study. To learn the skill of personal evangelism. To focus on the Scriptures necessary to know in teaching others how to follow Jesus Christ and obey the gospel.

What you will learn:

- 5 reasons why we should evangelize those who are lost
- How to build a dynamic devotional with Ten Minutes Alone with God
- That you are capable of teaching your friends the gospel and lead them to follow Jesus
- How contagious people in the New Testament led others to know Jesus Christ
- Seventeen places where you can find people who may be interested in studying the Bible
- Ten things you can do to open the door to your friends
- How to listen more effectively to those you are teaching
- Five questions to “break the ice” with the person you are wanting to reach
- Ten ways that you can teach your friends the gospel
- Four scenarios to help you set up the study with your friend
- Nine dynamic things involved in the gospel, which is the power of God for salvation
- Four important factors in persuading people to follow Jesus
- Twenty-two valuable tips to remember when you are conducting your study
- The “Take up Your Cross” Bible study
- How to close the study and ask for a response
- How to contrast their past responses with the scripture
- Find helpful passages that will support and explain the passages within the study
- How to handle objections to responding to the gospel
- Learn eight reasons to believe in God, the deity of Jesus, the reliability of the scriptures, the resurrection of Jesus, creation, and the freewill of mankind.

Event Participation

1. Students in grades 6-12 and adults may participate. This project can be done individually or by pairs. Since it is designed to teach people the gospel and lead them to “take up” their crosses, it can be used one-on-one or in small groups. Students are greatly benefitted to have experienced adults present in training and in practice.
2. Order the Sower material from the National Service Center. The entire *Sower: Evangelism for Everyone* book should be covered within the convention year. This study may be done in a Bible class, during home-school sessions, or another setting that suits the group. Classes may include both boys and girls, and adult men and women, since females were involved in personal soul-winning (not public preaching) in the New Testament (Acts 18:26; Titus 2:3-5).
3. Each study group must have an adult male mentor and leader who is responsible for tracking the progress of each group member.
4. Sessions should begin and end with prayers led by group members. Prayer requests should be taken and honored at the time of the opening prayer.

5. Each session should cover a chapter in *Sower: Evangelism for Everyone*. Class teachers may ask the students to read the chapters prior to class so that some time can be spent working the practice exercises.
6. All members of the class should participate in the discussion and in the practice exercises. The teacher/mentor should be present to facilitate the discussion and answer any questions that may arise.
7. After completion of this course, students/adults must make a presentation to someone who has not obeyed the gospel. Whether the person taught responds to gospel in baptism is not necessary for the student/adult to have completed the requirements for this award. The purpose for this course is to teach the skills necessary to lead a soul to Christ; students/adults cannot be held responsible for the decisions of those they teach.
8. The class teacher/mentor should complete the Sower verification form and sign it for submission to the Group Leader by the convention registration deadline date. The forms DO NOT need to be mailed to the National Service Center. **Group leaders are to electronically verify each participant of this event in the registration system.**

Awards

There will be recognition at the annual convention for all students/adults who complete the requirements listed above. Participant names will be listed in the convention yearbook.

Year- Round Event

Teach to Teach

This is a non-competitive event.

Purpose

To emphasize the importance of training teachers for Bible classes and encourage students and adults to study and become better prepared to teach God's Word.

Event Participation

Grades 7-12 and adults are eligible. Upon approval of the eldership or leadership of the local congregation, participants complete requirements on an individual level. The L2L organization does not promote students or adults participating in a Bible class in any way contrary to God's Word. Decisions about who is eligible to teach are a decision of the local eldership/leadership.

Level I: Student Teacher

Participants gain experience in the Bible classroom by completing the stated requirements. Participants can complete only one level per year.

Level II: Apprentice Teacher

Only those who have achieved the Student Teacher Level in a prior year may participate in the Apprentice Teacher Level. Participants use developed skills to teach others while improving the basic skills learned as a Student Teacher.

Level III: Master Teacher

Only those who have achieved the Student Teacher Level and Apprentice Teacher Level in prior years may participate in the Master Teacher Level.

Overview

While several participants may be completing requirements at the same time, the program is designed for individual completion. Participants are to complete their requirements individually (no team teaching to complete requirements; no teams creating lesson plans or teaching aids).

Training teachers to present God's Word has been a challenge to many congregations. Each level of this event becomes more challenging. This is by design so that when a student or adult becomes a Master Teacher, he/she will have developed into an excellent Bible class teacher of the Word of God.

Participants will keep a record (portfolio) of their work and update it as each level is completed. This record will be used at the end of the Master Teacher level and presented to the congregation's resource room or teacher work area. This is further explained on the Master Teacher event participation page. Participants must be registered before the convention registration deadline. **Group leaders are to electronically verify each participant of this event in the registration system.**

Event Rules and Guidelines

LEVEL I: STUDENT TEACHER

At this level, participants are introduced to the principles of teaching. Emphasis is on learning about teaching and observing good teachers in action.

Requirements:

- a. Students and adults should complete one of the following options:
 - Option One - The elders/leadership should appoint a mentor teacher to oversee and teach participants using the "Word to the Teacher" section of the Junior Leader Teacher's Edition book, which can be ob-

tained from the National Service Center.

- Option Two - Use appropriate teacher training material developed by the congregation.

Upon completion of either option one or two, the participant should have begun to develop knowledge of basic teaching skills.

- Observe a mentor teacher at two different class levels for six weeks each (total of twelve weeks of observation) from the following options: kindergarten, elementary, middle or high school. The observations do not have to be successive, but it would be good to have at least six weeks in one quarter and six weeks in another quarter. The eldership is responsible for deciding an appropriate class for students and adults to observe.
- During one of the class sessions, tell or read the Bible story for the selected lesson under the guidance of the mentor teacher.
- During one of the class sessions, help the class with a planned craft or activity for the selected lesson, or if the class is middle or high school, create a visual aid or lesson activity sheet to go along with one lesson under the guidance of the mentor teacher. Keep a copy of the craft, activity, or lesson activity sheet in the portfolio.
- Complete one of the following:
 - Option One - Observe and assist someone creating and putting up a bulletin board display. Report to the mentor teacher what has been learned about creating bulletin boards.
 - Option Two - Observe and assist someone painting and/or decorating a classroom for kindergarten, elementary, middle or high school. Report to the mentor teacher what has been learned about classroom decorating.
- After the twelve weeks of observation has been completed, write a one-page summary of the observations. Discuss what has been learned about teaching, keeping the interest of the students, and how to apply this to the participant's own teaching style. Submit a copy of the summary to the group leader and the eldership. Keep a copy in the portfolio.
- Take pictures of the bulletin board and/or classroom decorations to be used in the portfolio for the Master Teacher level.

LEVEL II: APPRENTICE TEACHER

At this level, participants learn to write a simple lesson plan, make teaching aids and actually teach Bible class.

Requirements:

- Must have completed the Student Teacher level in a prior year.
- Observe a mentor teacher at two different class levels for six weeks each (total of twelve weeks of observation) from the following options: kindergarten, elementary, middle or high school. The observations do not have to be successive, but it would be good to have at least six weeks in one quarter and six weeks in another quarter. The eldership/leadership is responsible for deciding an appropriate class for students and adults to observe.
- After the twelve weeks of observation, choose kindergarten, elementary, middle or high school and write two lesson plans using a lesson plan approved by the elders/leadership of the congregation. The participant can be assisted with the lesson plan by his/her mentor teacher. After completing the lesson plans, the participant should teach them during two separate class periods to a group of students under the supervision of a skilled mentor teacher. The eldership/leadership must be notified that the participant wishes to teach the class using the developed lesson plans and must give approval before participant teaches the lessons to a Bible class. Keep a copy of the lesson plan in the portfolio.
- Develop three teaching aids for teaching children. Ideas can be taken from Lads materials such as: *Junior Leader Teacher's Edition*, *GIFTS*, *GUARD*, *Pearls*, or *Field Book of Leadership: Revised*. Participants may also find ideas from bookstores, the internet, resource centers, magazines, and from mentor teachers.
- In one class session, help the class with a craft or activity, OR if observing middle or high school, bring an object or visual aid and teach a five minute Bible lesson to the class. Keep a copy of the work for the portfolio.
- With the help of the mentor teacher, create a bulletin board and put it up for display completely on their own, OR with the help of the mentor teacher, design and put together a classroom decoration on their own. Keep a copy of the material for the portfolio.
- Take pictures of the classroom and bulletin boards to be used for the portfolio for the Master Teacher level.

LEVEL III: MASTER TEACHER

At this level, participants will be progressing in their teaching skills. They will develop a file of lessons and co-teach one quarter in a Bible class session, either six or seven lessons with the mentor teacher observing.

Requirements:

- a. Students and adults must have completed the Student Teacher and the Apprentice Teacher levels before participating in this level.
- b. Write two lessons using a lesson plan approved by the elders/leadership of the congregation, or if the congregation already has a set curriculum, then write two lesson plans following the guidelines of the curriculum used by the congregation. Keep a copy of the lesson plans for the portfolio.
- c. Co-teach with a mentor teacher for one quarter in one of the following classes: kindergarten, elementary, middle or high school, rotating weeks, so that the participant teaches at least six weeks. Participants may use the following options:
 - Option One: The current curriculum of the congregation.
 - Option Two: Materials from L2L such as: *Junior Leader Teacher's Edition*, *GIFTS*, *GUARD*, *Pearls*, or *Field Book of Leadership: Revised*.
 - Option Three: If approved by the eldership/leadership, teach classes using the four lesson plans previously prepared by the participant.
- d. Continue to keep a file system for future use which includes a file for the four lesson plans developed during the Apprentice Teacher level and the Master Teacher level. Each file should contain all materials necessary for teaching each lesson including aids, activities, and handouts and may also include a CD copy. If materials are oversized and cannot be stored in a file, an explanation of the activity and location of materials should be included in the file.
- e. Develop three teaching aids for the classroom in addition to the lessons. A good idea for these aids might be items that can be repeatedly used (example: a game for which review questions can be changed, an activity to teach ongoing memory work like Bible books, etc.). These should be added to the file system.
- f. Complete the Master Teacher Portfolio. Include pictures of the teaching activities, created bulletin boards, decorated classrooms, crafts and lesson plans that have created. Include the summary of the first classroom observations and write a one page summary of the final co-teaching experience. This portfolio may be in the form of a scrapbook or a notebook. Submit the Portfolio to the mentor teacher and eldership for approval.
- g. Participants may participate in the Master Teacher level yearly by completing all the requirements during that convention year, adding to their filing systems and their teaching experiences. Materials from previous years cannot be used if participant continues to participate yearly in Master Teacher level.

Completion Guidelines

1. All required work should be completed prior to the convention registration deadline.
2. All materials will be turned in to the mentor teacher and evaluated on the local level. However, participants are required to complete all the listed requirements in order to be listed as recipients of the awards. Group leaders MUST verify that all requirements have been completed prior to the convention registration deadline.

GROUP LEADERS: Make sure that all participants have been registered and verified for the award. DO NOT send participants' work (essays, files, etc) to the National Service Center.

Awards

Qualified participants will be recognized at convention. Participant names will be listed in the convention yearbook. All materials will be evaluated at the local level.

Year-Round Event

Year-Round Bible Reading/Study

This is a non-competitive event.

Purpose

To promote year-round, local Bible reading in front of various audiences and to promote Bible study.

Event Participation

Participation is open to all students.

Event Rules and Guidelines

- a. The participant will volunteer to read scripture for the congregation, Ladies class, Bible class, etc. Work with the group leader and elders to arrange appropriate settings for these readings.
- b. The participant will choose applicable scriptures for the sick, disabled, bereaved, or younger children and read to them.
- c. The participant will demonstrate that they can find and read the Plan of Salvation to an audience. See Lesson 19 of the *Field Book of Leadership:Revised*.
- d. The participant must read an entire chapter of the Bible to an audience.
- e. The participant must successfully complete the Public Speaking Techniques/Microphone Guidelines Training under adult supervision. See Lesson 5 of the *Field Book of Leadership:Revised*.

As an additional resource, participants may gain experience reading scripture through the in-depth study of the scriptures and testing of their knowledge on the Apologetics Press Advanced Bible Reader (ABR) website (www.abrkids.net). Local coordinators can register as a teacher and then register students under his/her login and track each child's progress. This is not a requirement for this event but is a valuable resource to use in developing Bible reading skills and increasing knowledge through study.

Awards

Participants who complete the requirements shown above will be recognized with an award at convention. Participant names will be listed in the convention yearbook. All work must be completed prior to the convention registration deadline. Participants may qualify for only one award per convention year. **The group leader must electronically verify within the registration system that this award was earned prior to the close of registration.** At this time, awards are ordered based on registration. Therefore, it must be accurate. If a participant dropped out of this event or will not be able to complete the work, deregister them before registration closes.

Year- Round Event



Year-Round Bulletin Board

This is a non-competitive event.

Purpose

Participants will decorate a bulletin board at their home congregation several times during the year. Bulletin boards located in classrooms, hallways or other locations inside the church building can be decorated for the congregation.

Event Participation

This is an individual event for all students, as well as adults. Participants must have the approval of the local eldership/leadership.

Event Rules and Guidelines

1. Group leaders must guard the integrity of this event by making sure it benefits the congregation and is not just done to see how many bulletin boards can be put up and taken down again. Background paper/cloth may remain the same, but the border and all items on the bulletin board must be new to the board. Taking one item off a bulletin board and putting another up does not count.
2. There must be at least 5 items on the bulletin board, not including background or border. Examples of items that constitute one item would be: a title, a drawing, a picture, a figure, an information sheet, etc.
3. Ideas may come from a bulletin board book or another source, but the overall composition and design must be your own.
4. Since this bulletin board is to benefit the church or classroom, a mentor/teacher should guide the participant toward appropriate choices and make sure the work meets a high standard. The mentor should give suggestions but do none of the work.
5. Bulletin boards are to be counted from convention registration deadline to convention registration deadline, not January through December.
6. A record must be maintained and may be kept at the home congregation. The participant must be registered for this event before the Convention registration deadline. **Group leaders are to electronically verify each participant of this event in the registration system.** The National Service Center will use this to verify that the requirements are completed.

Awards

Awards will be given based on the number of bulletin boards made from convention registration deadline to convention registration deadline. Participant names will be listed in the convention yearbook.

- Bronze: 4-7 Bulletin Boards
- Silver: 8-11 Bulletin Boards
- Gold: 12 or more Bulletin Boards

Year-Round Event

Year-Round PowerPoint Presentation

This is a non-competitive event.

Purpose

Participants will create visual presentations designed to be used as visual aids that accompany biblical lessons. This event allows students to develop technical skills and creativity. Students are not required to present lessons, only create presentations that are used by a teacher, preacher or themselves.

Event Participation

This is an individual event for all students.

Event Rules and Guidelines

1. Entries in Year-Round PowerPoint must be registered in the convention registration system before the registration deadline.
2. Other presentation programs such as Prezi and Keynote may be used.
3. In Year-Round PowerPoint, students create presentations that are used in Bible class, sermons, VBS, Bible camp, etc. Students may also choose to create presentations that are used before services on Sunday morning or evening for announcements.
4. Presentations must contain a minimum of 20 slides, but may contain more as needed.
5. Lessons must teach Bible lessons and be scripturally sound.
6. Avoid excessive animation that detracts from the lesson. Check for grammatical or other errors.
7. Since the presentations are to benefit the church or classroom, a mentor/teacher should guide the participant toward appropriate choices and make sure the work meets a high standard. The mentor should provide technical advice and supervision but do none of the work.
8. Year-Round PowerPoint presentations are to be counted from convention registration deadline to convention registration deadline, not January through December.
9. The church leadership must verify that the presentations met their high standards and were used for church work. **The group leader must electronically verify within the registration system that this award was earned prior to the close of registration.** At this time, awards are ordered based on registration. Therefore, it must be accurate. If a participant dropped out of this event or will not be able to complete the work, deregister them before registration closes.

Awards

Awards will be given based on the number of lessons created and presented from convention to convention. Participant names will be listed in the convention yearbook.

- Bronze: 2-3 presentations
- Silver: 4-5 presentations
- Gold: 6 or more presentations

Year- Round Event



Year-Round Puppet Theater

This is a non-competitive event.

Purpose

An established team of puppeteers prepares and presents at least 10 presentations during the year as a teaching tool to reach out to the community. Examples include Vacation Bible School, children's training classes, hospitals, mission trips, schools, etc.

Event Participation

Participation is open to all students and will be held in the following divisions. Students younger than grade 3 may participate on any grade level team shown below. The team must participate in the division of its oldest member. Students may participate on one puppet team only.

- Grade 3
- Grade 4
- Grade 5
- Grade 6
- Grade 7
- Grade 8
- Grade 9
- Grade 10
- Grade 11
- Grade 12

Event Rules and Guidelines

1. A record of all performances by the puppet team must be kept. The majority of the performances must be by the same team members, but exceptions and emergencies are understandable. Therefore, substitute team members are allowed when needed.
2. Performance at convention is not to be counted. Practice performances for coaches, group leaders, and parents are not to be counted.
3. Performances are to be counted from convention registration deadline to convention registration deadline, not January through December. Participants are to be registered for this event before the convention registration deadline. **Group leaders are to electronically verify each participant of this event in the registration system.**
4. Puppeteering is not part of the worship service.
5. The target audience for Puppet Theater is children.

****Verification forms/lists DO NOT have to be mailed to the National Service Center.****

Awards

A. Team awards will be given for the number of presentations made from convention to convention.

Bronze 10-19 Presentations

Silver 20-29 Presentations

Gold 30 or more Presentations

B. This is a team award to be shared by all participants. Participant names will be listed in the convention year-book.

Year- Round Event



Year-Round Song Leading

This is a non-competitive event.

Purpose

To prepare young men to be accomplished song leaders by encouraging them to lead songs at worship assemblies, Bible classes, devotional groups, or other appropriate audiences, such as civic clubs or schools.

Event Participation

- All boys through grade 12 may participate.
- Lesson 8 of the *Field Book of Leadership: Revised* provides basic instruction on Song Leading. The *Field Book of Leadership: Revised* may be ordered by calling the National Service Center or by shopping in our online store.

Event Rules and Guidelines

1. Students lead songs a minimum of 12 times during the year before an audience, using no less than 3 different songs.
2. Students may do an accelerated program, or the program may be started in any month of the year. However, all work must be done within one, consecutive 12-month period.
3. Bronze requirements: Leading each of the 3 songs at least twice. It is preferred that the first and last song leading times be spaced apart for improvement opportunity. The student may lead more songs, but a minimum of 3 songs should be led. The student leads songs 12 times with each song to receive 1 point.
4. Silver requirements: Leading each of the 4 songs at least twice. It is preferred that the first and last song leading times be spaced apart for improvement opportunity. The student may lead more songs, but a minimum of 4 songs should be led. The student leads songs 18 times with each song to receive 1 point.
5. Gold requirements: Leading each of the 5 songs at least twice. It is preferred that the first and last song leading times be spaced apart for improvement opportunity. The student may lead more songs, but a minimum of 5 songs should be led. The student leads songs 24 times with each song to receive 1 point.

Award levels are as follows:

- 12 points receive a Bronze award (minimum of 3 different songs)
 - 18 points receive a Silver award (minimum of 4 different songs)
 - 24 points receive a Gold award (minimum of 5 different songs)
6. The student may lead as many verses as appropriate, but two verses (or twice through a song with one verse) is the minimum per song.
 7. As a student grows in ability, it is recommended that students choose a variety of songs with different tempos, time signatures, starting pitches, and meanings (Prayer, Lord's Supper, Praise, Devotional, etc). The overall purpose of this event is to expand the students' repertoire of songs that can be comfortably led, and to have a greater understanding of the situations when certain types of songs should be led. An additional benefit for the students is for them to gain experience and understanding in working with others in planning songs for worship, devotionals, etc.
 8. Students who participate more than once may not use songs led within the last year for this event, but must prepare a different set of songs. Lead these songs locally. There will be no convention participation in this event.

Documentation

To qualify for the award, documentation must be maintained for each student. The participant must be registered for this event before the Convention registration deadline. **Group leaders are to electronically verify each participant of this event in the registration system.** The National Service Center will use this to verify that the requirements are completed.

****Verification forms/lists DO NOT have to be mailed to the National Service Center.****

1. Students must keep a log of songs led. The log must contain the following documentary information:
 - Date
 - Title of Song
 - Place (e.g., church name)
 - Type of audience (e.g., Bible class, devotional, worship service)
 - Signature of adult verification
2. Evaluation sheets for at least two instances of two songs.
3. The official verification form from the Entry Forms and Log Sheets section of this rulebook.

Evaluation

1. Ask an adult in the audience (e.g., song leader for the congregation, youth director, minister, mentor) to evaluate the song from the audience and rate the student as good, excellent, or superior. This same adult should be used, if possible, for more than one evaluation to look for improvement.
2. Evaluators should be supplied with the official score sheet that the student should retain for his records. Ratings are: Superior: 85-100; Excellent: 70-84; Good: 50-69. These ratings do not reflect the level of award that the student receives. Rather, they are to help show the student the areas in which he did well and the areas that need improvement.
3. Once you have completed your evaluation, plan some time to sit down with the student and go over the areas in which improvement can be achieved.

Awards

Awards will be given at convention for the levels of Bronze, Silver, and Gold. Participant names will be listed in the convention yearbook.

Congregation Suggestions

Have a qualified song leader, if possible at your congregation, work with the students in this program throughout the year.

Evaluators' Instructions

1. Use the Year-Round Song Leading Evaluation Form
2. Be sure to completely fill out the student's name and group name. Please designate the type of audience(s) that the songs were led to (e.g., worship service, devotional, nursing home service) and whether this particular sheet is the initial evaluation or the final evaluation. Also, please include your name on the sheet.
3. Use a separate evaluation sheet for each time a song is led. There is room to also record the song title if you find that helpful. The student will be keeping a log of these same songs, so it is not mandatory. Please ensure the sheet marked "1st Leading" is used for all first time evaluations of songs, and the sheet marked "2nd Leading" is used for all final evaluations of the songs.
4. Once you have completed your evaluation, plan some time to sit down with the student and go over the areas in which improvement can be achieved.

Year- Round Event



Year-Round Songs of Praise

This is a non-competitive event.

Purpose

To prepare young women to be accomplished song leaders by encouraging them to lead songs at Ladies' Bible classes, ladies' devotional groups, Ladies' Day audiences, or other appropriate opportunities.

Event Participation

- All girls through grade 12 may participate.
- Lesson 8 of the *Field Book of Leadership: Revised* provides basic instruction on Song Leading. The *Field Book of Leadership: Revised* may be ordered by calling the National Service Center or by shopping in our online store.

Event Rules and Guidelines

1. Students lead songs a minimum of 10 times during the year before an audience, using no less than 3 different songs.
2. Students may do an accelerated program, or the program may be started in any month of the year. However, all work must be done within one consecutive 12-month period.
3. Bronze requirements: Lead each of the 3 songs at least twice. It is preferred that the first and last song leading times be spaced apart for improvement opportunity. The student may lead more songs, but a minimum of 3 songs should be led. The student leads songs 10 times with each song to receive 1 point.
4. Silver requirements: Lead each of the 4 songs at least twice. It is preferred that the first and last song leading times be spaced apart for improvement opportunity. The student may lead more songs, but a minimum of 4 songs should be led. The student leads songs 15 times with each song to receive 1 point.
5. Gold requirements: Lead each of the 5 songs at least twice. It is preferred that the first and last song leading times be spaced apart for improvement opportunity. The student may lead more songs, but a minimum of 5 songs should be led. The student leads songs 20 times with each song to receive 1 point.

Award levels are as follows:

- 10 points receive a Bronze award (minimum of 3 different songs)
 - 15 points receive a Silver award (minimum of 4 different songs)
 - 20 points receive a Gold award (minimum of 5 different songs)
6. The student may lead as many verses as appropriate, but two verses (or twice through a song with one verse) is the minimum per song.
 7. As a student grows in ability, it is also recommended that students choose a variety of songs with different tempos, time signatures, starting pitches, and meanings (Prayer, Lord's Supper, Praise, Devotional, etc). The overall purpose of this event is to expand the students' repertoire of songs that can be comfortably led, and to have a greater understanding of the situations when certain types of songs should be led. An additional benefit for the students is for them to gain experience and understanding in working with others in planning songs for classes, devotionals, etc.

Documentation

To qualify for the award, documentation must be obtained for each student. The participant must be registered for this event before the Convention registration deadline. **Group leaders are to electronically verify each participant**

of this event in the registration system. The National Service Center will use this to verify that the requirements are completed.

****Verification forms/lists DO NOT have to be mailed to the National Service Center.****

1. Students must keep a log for songs led. The log must contain the following documentary information:
 - Date
 - Title of Song
 - Place (e.g., church name)
 - Type of audience (e.g., female only Bible class, devotional, or worship service)
 - Signature of adult verification
2. Evaluation sheets for at least two instances of two songs.
3. The official verification form from the Entry Forms and Log Sheets section of this rulebook.

Evaluation

1. Ask an adult in the audience to evaluate the song from the audience and rate the student as good, excellent, or superior. This same adult should be used, if possible, for both evaluations to look for improvement.
2. Evaluators should be supplied with the official score sheet that the students should retain for her records. Ratings are: Superior: 85-100; Excellent: 70-84; Good: 50-69. These ratings do not reflect the level of award that the student receives. Rather, they are to help show the student the areas in which she did well and the areas that need improvement.
3. Once you have completed your evaluation, plan some time to sit down with the student and go over the areas in which improvement can be achieved.

Awards

Awards will be given at convention for the levels of Bronze, Silver, and Gold. Participant names will be listed in the convention yearbook.

Evaluators' Instructions

1. Use the Year-Round Songs of Praise Evaluation Form.
2. Be sure to completely fill out the student's name, group name, and participating grade. Please designate the type of audience(s) that the songs were lead to e.g., ladies class, ladies devotional, etc. and whether this particular sheet is the initial evaluation or the final evaluation. Also, please include your name on the sheet.
3. Please work with the student to ensure their opportunity to lead the songs in a forum that allows optimal learning experience. The initial evaluation is for you to see how well they can lead at the beginning of this event. After reviewing the initial evaluation with the student and working with them to improve weak areas, then plan additional opportunities for the student to show improvement. Ideally, the final evaluation should be performed just prior to the convention deadline for these forms to give maximum time for student participation and improvement.
4. Each evaluator's sheet can be used for the minimum 3 songs, even though it may span multiple song leading opportunities. There is room to also record the song title if you find that helpful. The student will be keeping a log of these same songs, so it is not mandatory. Please ensure the sheet marked "1st Leading" is used for all first time evaluations of songs, and the sheet marked "2nd Leading" is used for all final evaluations of the songs.
5. Once you have completed your evaluation, plan some time to sit down with the student and go over the areas in which improvement can be achieved.

Year-Round Event

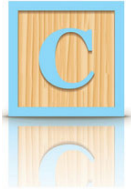

Year-Round Speech

This is a non-competitive event.

Purpose

To promote year-round, local public speaking. To prepare students to be accomplished speakers and Bible class teachers by delivering speeches to worship assemblies, Bible classes, devotional groups, or other appropriate audiences, such as civic clubs, ladies' days, lectureships, schools, etc.

Event Participation

- All students through grade 12 may participate.
- All students should study the *L2L Speech & Debate* book and lessons 4 & 5 in the *Field Book of Leadership: Revised* to develop their public speaking skills. Both may be ordered by calling the National Service Center or by shopping in our online store.

Event Rules and Guidelines

1. BRONZE LEVEL: Student prepares and gives 12 speeches during the year before an audience, using no less than 3 different speeches.
2. SILVER LEVEL: Student prepares and gives 18 speeches during the year before an audience, using no less than 4 different speeches.
3. GOLD LEVEL: Student prepares and gives 24 speeches during the year before an audience, using no less than 5 different speeches.
4. This is a year-round event. Local record keeping is essential. Participants must be registered before the convention registration deadline. **Group leaders are to electronically verify each participant of this event in the registration system before the registration deadline.**

****Verification forms/lists DO NOT have to be mailed to the National Service Center.****

5. Speeches do not have to be the student's original work. Students may use speeches from ministers, speech books, etc. Proper credit should be given. Also, older participants should do more research and preparation. Speeches must be at least 3 minutes minimum. However, the length of the speech may be determined by what is appropriate for the audience (i.e., a sermon might be 15 to 30 minutes long).
6. Students may do an accelerated program (speaking several times to various Bible classes), or the program may be started in any month of the year. However, all work must be done within one, consecutive 12-month period.

Award levels are as follows:

- Bronze: 12 total presentations (minimum of 3 different speeches)
- Silver: 18 total presentations (minimum of 4 different speeches)
- Gold: 24 total presentations (minimum of 5 different speeches)

Year-Round Speech File Folder

1. Students must maintain a file containing copies of their speeches for each of these lessons (electronic or paper files).

2. The file folder should contain the following documentary information:
 - a. The student must log each speech using the official Year-Round Speech Log Sheet located in the Entry Forms and Log Sheets section of this rulebook. The log must include:
 - Date of presentation
 - Title of speech
 - Place/Type of presentation (Church, Bible class, devotional, VBS, etc.)
 - b. The evaluation sheets: 6 minimum for each level (see requirements below).

Evaluations

1. Evaluations should take place throughout the period of the time the student works in this Year-Round Speech program (beginning, middle, and near the end). This is to show the progress the student should gain throughout this program. Evaluators should use the Local Evaluation Score Sheet. Ask two people (not parents of the speaker) to evaluate the speech from the audience and to rate the speaker as good, excellent, or superior. Evaluators should be a church leader or their spouse, preferably.
2. BOTH evaluators should be supplied with a score sheet that the student should retain for his/her records. Ratings are: Superior: 85-100; Excellent: 70-84; Good: 50-69. These ratings do not affect the level of award that the student receives. Rather, they are to help show the student the areas in which he/she did well and the areas that need improvement.
3. A minimum of two completed evaluation sheets for a minimum of three speeches (6 total evaluations) are required for Bronze, Silver, and Gold. Include the date of evaluation, the speech, audience, and signature of the evaluator. The evaluation sheets are not turned in to the L2L National Service Center. These are for the benefit of the participant to show progress for the year.

Awards

Awards will be given at convention for the levels of Bronze, Silver, and Gold. Participant names will be listed in the convention yearbook.

Congregation Suggestions

1. Publish the students' activities in the bulletin throughout the year, such as who spoke where and when.
2. Submit a newspaper-worthy picture and story about their accomplishments to the local newspaper.
3. Email a picture and a notation of these achievements to the L2L National Service Center for use in our newsletters and other publications. Include information about where they spoke, the date, and especially their topic.

Suggested Topics

1. Lessons from annual *PEARLS* study books, *GIFTS*, *GUARD*, *Headed to the Office*, or *Junior Leader*.
2. Lessons from the L2L *Field Book of Leadership: Revised*.
 - Acrostic Lessons
 - What the Word of God is Like
 - God Oversees the Nations
 - Freedom to Possess or Exercise
 - Trees Talk Purpose
 - Slanted History
 - Leader Pledges
 - Goal Setting

Local Evaluators' Instructions for Year-Round Speech

1. Personal Qualities - 25 points (Poise, Personality, Appearance, Attitude)
In this category, consider the speaker's appearance and personal qualities. Clothing should be clean, modest,

tasteful, and appropriate for the audience. Proper hygiene should be considered along with poise, personality, and the comfort zone of the speaker.

2. **Material/Organization Quality - 25 points (Value, Logic, Biblical Truth, and Scriptures Quoted)**
In this category, only the material and its organization presented by the student should be evaluated. One should consider the importance of adherence to the subject, and the logical and coherent development of the subject, which brings about a successful, logical, and adequate conclusion. Figures of speech, similes, metaphors, colorful choice of words, and zestful, descriptive phrases are important qualities. Scriptural accuracy and adherence to Biblical truths are critical to consider in this section.
3. **Delivery & Presentation - 20 points (Voice, Enunciation, Pronunciation, Gestures, Sincerity, Emphasis)**
Delivery and presentation should be evaluated upon several factors. Voice quality should be recognized in tone, pitch, and volume. Delivery should be continuous, without hesitation or halting, unless it is for the sake of emphasis. Enunciation and pronunciation are very important. Gestures should be noted for frequency, nature, and effectiveness. Movement and gestures should not be awkward. Sincerity and enthusiasm are important qualities. The desire to be convincing should be obvious. Emphasis should be well-placed and dynamic, but not overdone.
4. **Overall Effectiveness - 20 points (Appeal, Impression, Effect, Did It Make Sense?)**
In this category, the overall impression created by the speaker and the speech should be rated. The overall impression of a specific effect is a result of many factors, some of which are indefinable and inexpressible and cannot be individually scored. Yet, the final impression persists and is most important. In this phase of scoring, this general overall impression is given actual point value. Was the speech effective? Did it hit the target?
5. **Audience - 10 points (Appeal, Impression, Effect, Appropriateness for the Audience, Held the Audience's Attention)**
It is important for students to learn what speeches to give to what audiences. In this category, the evaluators should evaluate the appropriateness of the speech topic for the audience present (ex., civic club vs. Bible class).

Pre-
Convention
Event



Bible Bowl Individual Test

Purpose

To enable participants to enhance knowledge of textual content; to develop quick reference to Bible facts and gain knowledge of Scripture.

Event Participation

1. Any individual student in grades K-12 may prepare for and take the test to qualify for an individual award. For the Individual Test High Score ONLY, there will be a K-2 division.
2. Questions will be worded from the New King James Version, stating the specific chapter and verse. Study materials may be ordered from the National Service Center. Bible Bowl study questions are available in Word and PowerPoint formats.
3. There is also a new Event Training Videos page on the L2L website under the Convention tab with helpful videos for several events.

Event Rules and Guidelines

1. You do not have to be a member of a team to take the individual test, but any team that wishes to participate in the oral Bible Bowl at convention must have four team members registered as a team by the registration deadline listed in the Convention Themes & Deadlines section of the L2L website.
2. All testing will be done online. Students will be assigned a unique ID number and access code to take the tests during the time frame above. Group leaders will receive the IDs and codes for their registered students prior to the start of the testing period. These IDs are unique to each student, so please do not give the ID and code to a student that was intended for someone else. The URL for the test login page is <https://www.zipgrade.com/s/>
3. Since some of the students taking the test will be young and may have trouble reading, the questions and answer choices may be read to them by an adult. However, Bible verses are not to be read along with the questions.
4. Students in grades K-6 will take a 60 question multiple choice test. Students in grades 7-12 will take a 100 question multiple choice test. Individual awards will be given based on the scores of the written test. Students will be compared to others in their same grade level. This is not a pass or fail grade.
5. Do not wait until after the test deadline to attempt to resolve problems such as accessing the test website, missing student IDs, etc. Contact the National Service Center at any time to resolve problems with the test.

Awards

1. The top 10 scores on the written test in each grade division receive High Score awards.

Pre- Convention Event



Mass Communications

Purpose

To train Christians to communicate effectively with information and technology.

Event Participation

1. Students may participate in any or all of the following four categories. Boys and girls may participate together in all categories.
 - Blogging
 - Podcasting (Entries within a grade division will all be judged against each other, whether they are one participant or a team of two participants.)
 - Storyline
 - PowerPoint Presentation
2. In each category of participation, there will be three grade divisions:
Grades 3-6 Grades 7-9 Grades 10-12

General Event Rules and Guidelines

1. **Mass Communications entries will no longer be uploaded to the registration portal server. As students are registered for their categories, a URL (web address) will be entered in a corresponding space for the entry. This URL will be required in order to register for the category, so be sure to have all information before attempting to register students. Details for each category's entries are in their respective sections.**
2. **All entries must be submitted by the convention registration deadline. Late entries are ineligible.**
3. All entries (i.e., blogs, podcasts, storylines, and PowerPoints), will become property of L2L and may be used to train and to encourage other groups as they prepare for the event.
4. Refer to the Evaluation Forms section of this rulebook to see the judging forms that will be used in this event. This helps the students and adult coaches to understand the evaluation categories for the event.

Judging

1. Each category of participation will follow its own event rules.
2. The number of entries will determine how judging takes place. There may be times when all places for a grade division in a category may be awarded at a convention location/color other than your own.

Awards

First, second, and third place awards will be given for each category in each grade division. The number of entries will determine how judging takes place. There may be times when all places for a grade division in a category may be awarded at a convention location/color other than your own.

Blogging

Event Rules and Guidelines

1. This event involves a blog post suitable for publication on a website such as *Gospel Advocate*, *Christian Woman*, etc. L2L and *Gospel Advocate* may use any blog for marketing purposes and/or submit it for publication. Winning entries may be published on the L2L Facebook page. L2L reserves the right to publish any or all of the non-winning stories on the L2L Facebook page.
2. The following guidelines apply:
 1. The content of the blog post must be related to the selected convention theme and biblically accurate.
 2. The entry must not be a speech, but a blog prepared for publication.
 3. Each blog entry must be the entrant's original work, in its entirety, and must not infringe on the intellectual property or other rights of any other third party, regardless of country of residence. It is the entrant's responsibility to clear all aspects of copyright.
 4. The blog must be between **350-750 words**.
 5. The blog **must** be written and compiled completely by the student. Adults may proof for spelling errors or arrange for the material to be typed.
 6. L2L reserves the right to disqualify any blog entry which infringes the copyright or other intellectual property rights of third parties. This includes copyrighted photographs used without express permission within the blog. L2L is not responsible or in any way liable for any violations of copyright or any other unauthorized use of images/graphics/video or other content of submitted entries.
 7. Any blog entry containing rude, unlawful, discriminatory, sexually explicit, or libelous material will not be accepted. Any entry containing promotional material, endorsement, or advertising will not be accepted.
 8. **Submissions must be uploaded by the student to a website (check Google for free options), Facebook, or other electronic resource that is readily accessible by anyone so that it can be judged.**
3. Criteria for Scoring:
 1. Content (Biblical accuracy, clarity of principle presented)
 2. Adherence to convention theme
 3. Composition (introduction, development of thought, conclusion or summary statement)
 4. Grammar, syntax, and vocabulary (actual use of the language)
 5. Reader appeal (creativity, timeliness, and continuity of thought)
4. Penalties:
 1. Any self-identification within the blog by the participant will be penalized three points.
 2. Students will be penalized two points for one to 25 words over or under the word limit; four points for 26 to 50 words over or under the word limit; etc.

Entry Submission

In the L2L Registration Portal, the group leader will check the box for Blogging. The blog file will be posted to a website where it can be accessed by anyone. In the text box next to the category name, enter the URL for the blog. This is **required** to register for this category.

Judges' Instructions for Blog Entries include evaluation in the following categories:

1. Content – 20 points (Biblical accuracy, clarity of principle presented)
2. Adherence to theme – 15 points
3. Composition – 25 points (Introduction, development of thought, and summary)
Judges will critique organization and structure in the student's writing. The flow of the student's thoughts should be smooth and logical in order.
4. Grammar, syntax, and vocabulary – 20 points
Proper grammar, vocabulary and sentence structuring should be found in the composition.

5. Reader Appeal – 20 points (Creativity, timeliness, continuity of thought)
Figures of speech, similes, metaphors, colorful choice of words, and zestful, descriptive phrases are important qualities. The writing should be interesting for the reader from beginning to end.

Podcasting

Event Rules and Guidelines

1. To enter, one participant, or a team of two participants, must submit an audio file featuring the student(s) discussing a topic of their choosing (the “Submission”). The Submission must be both “original” (as defined by copyright law) and unique (meaning it must have been created for the sole purpose of entering the event). Submissions must comply with the following requirements:
 1. Submissions must be between three (3) and six (6) minutes in length.
 2. Submissions must be created specifically for the event.
 3. Submissions must be the original work of the student(s). Adults, however, may help upload the recording.
 4. Submissions must be uploaded by the student(s) to a podcasting site, such as SoundCloud, Anchor FM, or others (in any format acceptable to the site). The ability to download the submission should be enabled. Submissions must comply with the site’s Term of Use. These and other sites have a Basic level that are free.
 5. Submissions must not contain material that violates or infringes another’s rights (including, but not limited to, material that violates privacy, publicity, or intellectual property rights).
 6. Submissions may not include any material that infringes the intellectual property rights of any person. Please be respectful of copyright and trademark laws. All material must be original to the persons who creates the podcast. Pre-recorded music may not be used. Students may include live performances of public domain songs or non-copyrightable rhythm elements. For avoidance of doubt, for the purposes of these Official Rules, “public domain” does not mean “publicly available;” it means that copyright has expired, and the material is no longer under copyright protection. We encourage students to err on the side of excluding music if the student is not sure whether the music is copyrighted or not. Entries will be disqualified if they contain materials that appear to infringe copyrights, trademarks, or other intellectual property rights of others. Songs or chants made up by students are acceptable as long as they are performed live on the recording and student notes in student’s Explanation document that the song/chant was composed by student.
 7. By submitting an entry, you affirm that you own all the rights to any and all musical content in your submission, including but not limited to the right to reproduce, distribute, and publicly perform. For examples of what is and is not public domain work, you may visit <https://copyright.cornell.edu/publicdomain>
2. Submissions may be on any topic related to the L2L theme for each convention year; however, the following prompts are offered as suggestions:
 1. Tell us a story about your school or community: about something that happened there – recently or in the past — that you would like your audience to know.
 2. What is a moment in history which all students should learn?
 3. Show us both sides of a debate about an issue that’s important to you.
 4. Explain something that youth understand and adults may not.
3. Rules regarding identification of participants:
 1. The student(s) must upload a publicly viewable and downloadable Submission to a podcasting site between the day registration opens and the day registration closes. If a team of two students records the podcast together, only one student needs to upload it to the site.
 2. In addition to the audio of the podcast, the student(s) must write an explanation of the Submission (up to 200 words in .doc, .docx, or .pdf format). This is not a verbatim script of the podcast, but an explanation of what is discussed. Save it to a cloud storage site that allows you to create a link for sharing. Free options are available from Dropbox, Google Drive, and others. Verify that

the link works by sending it to someone to make sure they can open it. If a team of two students records the podcast together, only one student needs to upload the explanation.

4. Time limit and penalties:
 1. Presentation must be 3 to 6 minutes for all ages.
 2. Students will be penalized two points for up to 30 seconds over or under the time limit; four points for 31 to 60 seconds over or under the time limit; etc.
 3. Any self-identification by the participant(s) shall be penalized three points.

Entry Submission

In the L2L Registration Portal, the group leader will select the grade division for the student and select the team letter (A for the first entry, B for the second entry, etc.). If two students work together on the podcast, select the grade division of the older student for each one and the same letter for each of them. In the **Entry** text box next to the category name, enter the URL for the podcast. In the **Explanation** text box, enter the URL for the written explanation. These are **required** to register for this category. If two students work together on the podcast, the URLs must be entered for each student's registration.

Judges' Instructions for Podcasting Points will be awarded to participants in the following categories:

1. Content – 20 points: Adherence to theme, clarity of principle presented, biblical accuracy.
2. Information and Structure – 30 points: Does the Submission tell a compelling story or teach something new and important? Is it structured in a way that makes sense and keeps listeners engaged? Can the listener easily follow the story you're telling or the information you're explaining? Have you spent time editing — cutting out unnecessary information or repetition and making sure the main ideas come through clearly?
3. Personality and Creativity – 30 points: Judges want to listen to this Submission and *hear* your voices. Does it have personality, or does it make listeners want to "fast forward?" Does it make the listener laugh, cry, or leave them deep in thought — or FEEL something? That makes a great podcast.
4. Production – 20 points: Podcasters are not judged on how fancy the equipment is, and you are not expected to be an expert on recording and editing sound but try your best. Some Submissions may use sound or audio in creative ways. Others may be more of an interview format. If you use sound, does it add to the story you're telling? These are some of the things listeners will be looking for.

Helpful hints for first time podcasters:

1. **Limit your podcast to 3 to 6 minutes.** Check the length of your audio file and make sure it is no longer than 6 minutes, or penalties will be assessed.
2. **Use your limited time well.** Your podcast must include a beginning, middle, and end to produce a complete listening experience. Beginnings often draw the listener in or provide context. Endings often offer a summary, raise a question, or act as a teaser for the next segment. That said, your submission can be an excerpt from a longer podcast, as long as you demonstrate thoughtfulness about how you are using time. An end can be a hard "end" of a podcast, but it can also be the end of a segment, or even the end of an introduction within a longer episode. **One more thing:** Try not to do too much in your short podcast. Often the most rewarding podcasts are ones that dive into a specific issue or story.
3. **Use any podcast format or genre.** Popular podcast formats include, but are not limited to, interviews, conversations, non-fiction storytelling, and fiction storytelling. Popular podcast genres include, but are not limited to, comedy, news documentary, history, radio theater, and sports.
4. **Be sure to use non-copyrighted sound effects or music.** You cannot use copyrighted sound effects or music for the sole purpose of making your podcast sound better. Instead, you can find royalty-free music and sound effects on [Bensound](#) or [Freesound](#), or by doing a web search for royalty-free files. Or you can use audio editing software to create your own music or sound effects.

A Quick Guide to Creating a Podcast

Step 1: Listen to podcasts. Become familiar with different formats and genres. Figure out which podcasts you like best.

Step 2: Figure out what you want to do in your podcast. Do you want to entertain listeners or provide infor-

mation, or both?

Step 3: Create a podcast plan or outline

Step 4: Make sound recordings. Whether you tell a story, have a conversation, or interview people, you'll need to create recordings. If you want original music or sound effects, you'll need to create those recordings as well.

Step 5: Gather other sound files. Will you be including other sound effects, music, or media clips? Find those files, but make sure you are not violating any copyright laws.

Step 6: Make sure your podcast has a beginning, middle, and end. While we're not saying what those sections have to be or how long they should last, we want you to make sure your podcast is a complete listening experience. Be thoughtful about how you implement your podcast.

PowerPoint Presentation

Purpose

Participants will create presentations designed to be used as visual aids that accompany biblical lessons. This event allows students to develop technical skills and creativity. Students will not present a lesson; only create a visual presentation that could be used with a lesson. Students may use any presentation program they desire, such as PowerPoint, Prezi, Keynote (saved in .ppt or .pptx format), Google Slides, etc..

Event Rules and Guidelines

All presentation entries must be submitted by the convention registration deadline.

1. Bible Lesson: Students create a visual presentation that could be used in support of **Chapter 9: "Picking Godly Friendships" by Dr. Ralph Gilmore in the 2023 Pearls Study Book, *Building Godly Homes***. The students are not required to present the lesson, but they are to create a visual aid that could accompany a teacher's presentation of the Pearls lesson.
2. Presentations must contain **20 slides – no more and no less**. Penalty is -5 points per slide over or under the 20 slide limit. The presentation should not contain the student's name, group name, or group city and state. Penalties will be applied for violations.
3. Students should check to make sure their presentation is compatible on different computers and operating systems.
4. Penalties will be applied for excessive animation that detracts from the lesson and for grammatical or other errors.
5. Since the presentation is to benefit the church or classroom, a mentor/teacher should guide the participant toward appropriate choices and make sure that the work meets a high standard. The mentor should provide technical advice and supervision but do none of the work.
6. Copyright laws must be followed when including pictures, art, poems, etc. Penalties will be applied.

Entry Submission:

In the L2L Registration Portal, the group leader will check the box for PowerPoint Presentation. In the text box next to the category name, enter the URL for the file. This is **required** to register for this category. For PowerPoint or Keynote files, save them to a cloud storage site that allows you to create a URL for sharing. Free options are available from Dropbox, Google Drive, and others. Verify that the link works by sending it to someone to make sure they can open it. For online presentation services like Prezi or Google Slides, enter the URL for the presentation. Make sure that the settings for the presentation allow for anyone to open and view the files.

Judging:

Entries will be judged and evaluated based on the following criteria:

1. Biblical message - 25 points (Adherence to the specified chapter of the Pearls book and inclusion of a biblical message)
2. Scriptures used - 20 points (Appropriate inclusion of scripture references from the chapter to properly present the intended message of the author)
3. Appearance - 20 points (Use of appropriate background and text colors for effective use in any setting)

4. Creativity - 15 points (Be creative to keep the interest of the audience, but do not go to extremes that will detract from the lesson being presented)
5. Overall usefulness - 20 points (How easily this presentation can be used by a teacher to present the lesson effectively and with limited additional input)

Storyline

Event Rules and Guidelines

1. This event involves a dramatized Bible story, Bible truth, or moral lesson presented in a video format. Participants use live dramatization (no puppetry, please) adhering to the following guidelines:
 - The content of the Storyline should be related to the selected convention theme and biblically accurate.
 - The Storyline presentation should be a team effort involving **no fewer than three active team members and no more than 15. This number does not include skits that use a larger number for a crowd scene.**
 - Teams participate in the division of the oldest member of their group.
 - Watch the finished entry prior to submitting it.
 - Audio must be reasonable quality in order for judges to understand. Try buying a microphone which connects to the camera and has a long cord. Tape the microphone and cord to a broom stick or piece of PVC pipe and hold it over the actors, just out of camera view. This technique has brought a lot of success.
 - Do not rely on fancy transitions or special effects. The story and the presentation of the actors is the most important aspect of the video. Transitions can make the video more interesting and appealing, but will not overcome a poor storyline or lack of biblical message.
2. Rules regarding time limits and penalties.
 - The Storyline must be three to four minutes in length for all ages.
 - Students will be penalized two points for one to 10 seconds over or under the time limit; four points for 11 to 20 seconds over or under the time limit; etc.
 - Any self-identification by the participants shall be penalized three points.

Entry Submission

In the L2L Registration Portal, the group leader will check the box for Storyline. The video file (script is no longer required) will be uploaded to YouTube, Vimeo, or a website where it can be accessed by anyone. In the text box next to the category name, enter the URL for the video. This is **required** to register for this category. The URL must be entered for the first student on a team. Each additional team member will have the link automatically assigned to them.

Judges' Instructions for Storyline

Although the technical aspects of video presentation, such as lighting, transition shots, editing, etc., are important to quality, these are not specific categories of judgment for this event. However, biblical message, video and audio qualities are very important and certainly influence the overall impression and effectiveness.

Points will be awarded to participants in the following categories:

1. Content (Biblical accuracy, adherence to theme, clarity of principle presented)
2. Creativity (Dramatization, sound effects, audience appeal)
3. Character Representation (Appearance, poise, personality, attitude)
4. Costumes (Authenticity, appearance)
5. Set (Authenticity, appearance, creativity)
6. Dialogue (Continuity, transition between characters)
7. Overall Effectiveness (Appeal, impression, effect)

Pre- Convention Event



Pearls

Purpose

To provide students with a deeper study into the Bible Bowl book selected for the convention year.

Event Participation

1. Students will participate in five grade divisions for the written test:
 - Grades 3-4
 - Grades 5-6
 - Grades 7-8
 - Grades 9-10
 - Grades 11-12

The annual Pearls Study Guide material may be ordered from the National Service Center or through the L2L online store.

Event Rules and Guidelines

1. Students will take the written test individually.
2. Questions will be based from a study guide that will be made available from the National Service Center each year. The study guides are excellent classroom material.
3. All testing will be done online. Students will be assigned a unique ID number and access code to take the tests during the time frame above. Group leaders will receive the IDs and codes for their registered students prior to the start of the testing period. These IDs are unique to each student, so please do not give the ID and code to a student that was intended for someone else. The URL for the test login page is <https://www.zipgrade.com/s/>
4. For students that have problems reading, the questions and answer choices may be read to them by an adult. However, no student may take the test "open book."
5. There will be two different tests given – one for the students in grades 3-6 and one for students in grades 7-12. Please make sure that the correct test is given to the correct grades because the answer keys will be different.
6. Students will be compared to others in their same grade level. This is not a pass or fail grade.

Judging

1. The written test will be individually scored.
2. Before the tests are mailed, double-check to make sure that all students' information is complete, accurate, and legible on the answer sheets. Each must include the student's name, grade they are currently in, color division (where applicable), and congregation name, city, and state. It is recommended that copies of the answer sheets be kept in case there is a problem with getting them to the coordinator.

Awards

The ten top scores in each age division on the written test will be recognized.



Art Says It

Purpose

To offer participants an opportunity to use their talents, skills, and artistic abilities via art media to communicate a biblical message related to the annual convention theme.

Event Participation

1. Art Says It is an individual event. While adult guidance is appreciated, the creation and production of the artwork must be the responsibility of the student.
2. Participants in grades 3 through 12 are divided into the following grade divisions for all categories, except Bulletin Board and Poster (grade divisions listed below):

Grades 3-4	Grades 5-6	Grades 7-8	Grades 9-10	Grades 11-12
------------	------------	------------	-------------	--------------
3. Pre-K through grade 2 and Bartimaeus participants may participate in a non-competitive area of Art Says It. See the Art Says It (Display Only) section for information.
4. Individuals may only submit one entry per category in any of these five categories:
 - Drawing/Sketching: pen/ink, pastel, chalk, crayon, charcoal stick and pencil, graphite pencil, and colored pencil
 - Painting: oil, tempera, watercolor, acrylic, and airbrush
 - Photography: original or digitally enhanced
 - Poster: Grades 3-6 only (two grade divisions: 3-4 and 5-6 for evaluations)
 - Bulletin Board: Examples include seasonal decoration, information on mission works, camp or other activities of the church, or a Bible lesson or concept depicted (grade divisions for Bulletin Board only are 3-4; 5-6; 7-9; 10-12)
5. In order to speed up the process of turning in artwork at convention, prior to turning it in, participants or group leaders should use a dot sticker on the front of the artwork to indicate the grade division of the student and a code for the category (list is below). If you are unable to do this prior to convention, it will be added when it is turned in. For conventions with multiple colors, it is important that your dot sticker be the correct color for your group's color division. The Art Says It entry form (available in a later section of this rulebook) is to be attached to the back of the entry.
 - DS for Drawing/Sketching
 - PA for Painting
 - PH for Photography
 - PO for Poster
 - BB for Bulletin Board

Event Rules and Guidelines

Entries in each of the four categories will be judged for construction, content and creativity.

1. Construction (Type of Material):
Effective Use of Materials/Media – Workmanship should reflect the thought and time that the artist took in creating the piece, as well as overall quality, including neatness and composition.
2. Content (Topic of Work):
Emphasis should be on glorifying God, serving others and imitating Christ. Artwork should adequately reflect the theme of the convention.

3. Creativity (Design):
Originality – uniqueness
Design – layout, neatness, organization
Overall Appeal – impression (this is very subjective)
4. Refer to the Evaluation Forms section of this rulebook to see the forms that will be used by the judges in this event. This will help the student in preparation for the event to see exactly what the judges will be looking for.

General Rules for Construction, Content, and Creativity

1. The artwork entries for Painting and Drawing/Sketching must be at least 8 1/2" x 11", but must not exceed 16" x 20". Entries are NOT to be matted or framed to allow for concentration on the artwork and not the embellishments. A penalty deduction of five points will be applied to entries with frames and/or mattes. No "paint by numbers" will be accepted. Please make arrangements for the artwork to safely travel to convention without getting damaged.
2. Photo entries for Photography may be color or black and white. All photo entries must be at least 4" x 6" and must not exceed 8 1/2" x 11". Entries are NOT to be matted or framed to allow for concentration on the photo and not the embellishments. A penalty deduction of five points will be applied to entries with frames and/or mattes. Photos may be digitally enhanced and may include a title, if desired.
3. Posters should be on standard poster board (22 inches by 28 inches). No copyrighted figures (such as cartoon figures) may be used, unless written permission is acquired. Participants must be in grades 3-6. There will be two grade divisions for evaluations: 3-4 and 5-6.
4. Bulletin Board entries are submitted at convention as an 8x10 landscape photograph. No mattes or frames. No digital enhancement is allowed. Copyrighted figures (such as cartoon figures) may not be used, unless they are purchased for use on bulletin boards or you have approval to use them. Titles and lettering are not required on bulletin boards, but the bulletin board must clearly convey a thought. Taking one item off a bulletin board and putting another up is not acceptable. Background paper/cloth may remain the same, but the border and all items on the bulletin board must be new to the board. Ideas may come from a bulletin board book or another source but the overall composition and scheme must be your own. Since this bulletin board is to benefit the church or classroom, a mentor/teacher should guide the student toward appropriate choices and make sure the work meets a high standard. The mentor/teacher should give suggestions, but do none of the work.
5. Titles and descriptions are not required for art entries, but may be included, if desired, to better associate the work with the annual convention theme.
6. Do NOT sign your work prior to the judging. Neither the student's name nor congregation should appear on the face of the entry.
7. Do not enter artwork which previously has been entered in an L2L Art Says It event. Only new entries are acceptable.
8. A copy of the Art Says It Entry form found in a later section of this rulebook should accompany each entry.
9. Artwork must be received at the Art Says It registration desk on Friday at the scheduled time (see Convention Schedule of Events) and should remain on display until the posted time on Saturday. Art registration will officially close at the scheduled time of the judges' meeting (check Convention Schedule of Events). Art entries received after that time will be accepted and added to the tables for judging ONLY AS TIME ALLOWS. After judging begins, art will be accepted for display only.
10. Groups are responsible for picking up all artwork by the posted time on Saturday. Items left behind will usually be discarded in the trash by the hotel staff.
11. Each entry is eligible for only one award. A student may enter only one piece of art in a category. The same piece of art cannot be judged in more than one category.

Judging

1. Based on the above rules, artwork will be judged according to the official evaluation form included in the Event Rulebook.
2. Three to five judges (preferably with art backgrounds) will work independently to examine and score each art entry. The combined rankings of all the judges will determine the winners. Each congregation must provide one qualified judge for each four art entries based on the following example: one judge for the first 1-4 entries; 2 judges for 5-8 entries, etc.
3. Penalties
 - Any self-identification by a participant shall be penalized three points, with the exception of Bulletin Board entries.
 - Entries that do not meet the size requirements previously stated shall be deducted five points.
 - Entries with mattes or frames will be penalized five points.
 - Improper use of a copyrighted image, such as cartoon characters, will be penalized ten points.
4. For more information on serving as a judge, check out the informative videos on our website here - <http://www.lads2leaders.com/judges-training>

Awards

- The Art Gallery concept that encourages people to view the students' entries has been expanded to allow more time to view the art and reduce the crowd from all being in the room at one time. The room will open after judging is completed. It will remain open for approximately 24 hours. This will allow for more time to view the entries without being rushed.
- Additional signage will be used to make locating the art items easier.
- In order for as many people as possible to see the entries, we ask that students leave their artwork in place until close to the posted closing time on Saturday.
- There will be a list of place winners posted in the Art Gallery Room where the entries are displayed. Another list will be posted at the Information Booth.
- Additionally, each of the entries that place in the top three and all finalists will be marked with a small ribbon placed on the entries at the conclusion of judging. This will allow those viewing the entries to know which ones placed, as well as giving photo ops with the students and their entries at their convenience. You can share these photos on Instagram or Facebook using the designated hashtag for the year so that we can possibly use them on the screens before the awards ceremonies.
- All award winners will be called to the stage in groups to receive their ribbons and have photo opportunities on stage.

First, second, and third place awards will be given in each of the grade divisions for each category. When the number of entries in a category exceeds 20 in any one grade division, finalist awards will also be given. Winners in Painting and Drawing/Sketching categories may have the opportunity to help with illustrating Bible curriculum for young kids.



Art Says It (Display Only)

Purpose

To offer participants a non-competitive environment to demonstrate their talents, skills and tools of drawing and other art media. In order to communicate a Biblical message related to the annual convention theme. Art is very subjective. This event will serve as an art gallery for the display of your work and talents.

Event Participation

1. Pre-K through grade 2 and Bartimaeus participants (all ages) may participate in the following categories:
 - Greeting Card
 - Collage
 - Sculpture
 - Drawing/Sketching
 - Painting
 - Photography
 - Posters
2. Group Leaders should register individuals participating in non-competitive Art Says It events. Please note that deregistering is required when the participant elects not to participate or display their art. Event space and display tables are provided to L2L at a premium. Help us control convention costs by reducing the over-reserving of event space and display tables.
3. Since these categories are non-competitive, names and other identifying information are permitted. All artwork should relate to the annual convention theme. Certificates of participation will be available on the L2L website.
4. Art Says It (Display Only) is an individual event. The creation and production of the artwork must be the responsibility of the participants.

Event Rules and Guidelines

Entries should follow the same guidelines as Art Says It for construction, content, and creativity even though they will not be judged.

1. Construction (Type of Material):
Effective Use of Materials/Media – The work should reflect that the artist gave thought and time to creating the piece. The overall quality of the piece should show workmanship, including neatness and composition.
2. Content (Topic of Work):
Emphasis should be on glorifying God, serving others and imitating Christ. Artwork should adequately reflect the theme of the convention.
3. Creativity (Design):
Originality – uniqueness
Design – layout, neatness, organization
Overall Appeal – impression

General Rules for Construction, Content, and Creativity

1. Greeting Cards category is designed so that children can learn how to make handmade cards for individuals. Handmade cards are also part of Good Samaritan. Greeting Cards must be handmade and not computer

generated. This is an activity that promotes creativity and encourages others to send greeting cards to the sick, etc.

2. Sculpture entries are to be no larger than 24" x 24" x 24". Sculpture entries should be entirely the work of the participant. No pre-cast molds accepted.
3. Collage should not exceed 16" x 20".
4. See the Art Says It section for details on Photo, Painting, Drawing/Sketching, and Poster entries.
5. Titles and descriptions are not required for art entries, but may be included, if desired, to better associate the work with the annual convention theme.
6. Art must be received at the Art Says It registration desk on Friday at the scheduled time (see Convention Schedule of Events) and should remain on display until the posted time on Saturday.
7. Groups are responsible for picking up all artwork by the posted time on Saturday. Items left behind will usually be discarded in the trash by the hotel staff.

Categories

Participants can submit only one entry per category.

1. Collage: textile, fabric, and any other material combined together. Collages can be attached to poster board or can contain three-dimensional images or projections.
2. Greeting Card: paper, fabric, foam, yarn, etc. Expressions, poems, etc., may be included but must be either student's original thought or a Biblical message. Cards should be handmade artwork and design. No computer-generated work is admissible.
3. Sculpture: carving, molding, or welding of any material. Materials must be formed or manipulated in some manner.
4. Poster
5. Painting: oil, tempera, watercolor, acrylic, and airbrush
6. Drawing/Sketching: pen/ink, pastel, chalk, crayon, charcoal stick and pencil, graphite pencil and colored pencil
7. Photography: black & white or color

Banner

Purpose

To encourage team organization and creativity among participants in the creation of banners to be displayed at group functions, youth rallies, church, or in the community.

Event Participation

Congregations may enter only ONE banner for this event.

Event Rules and Guidelines

1. Banners shall sum up the personality of the team. Banners are a team expression. Each team has its own unique personality, and the banner should reflect such.
2. Unlike other events, banners do not have to reflect the annual convention theme.
3. Banners must be received at the Banner Registration Desk on Friday at the scheduled time (See Convention Schedule of Events). A group representative will fill out an official entry form at that time.
4. Banners must display the L2L name or the “Flying L” logo. Banners without the name or logo will be disqualified.
5. The local program must be identified, including the city, state, and congregation within the design of the banner. Banners that are not identified will be penalized.
6. Maximum dimensions are 28” by 22”, including foldouts, fringe, or floating objects. (This is the standard size of poster board and is convenient for transportation.) Banners may be designed in either portrait (tall) or landscape (wide) format. There is no depth restriction. The measurements exclude any rope or hanging device.
7. Banners must be constructed to be easily moved and displayed on an easel provided by the congregation. Some hotels are able to provide easels, but please do not count on it. Be prepared in case the hotel does not have easels in its inventory.
8. Banners must not require an electrical outlet.
9. No copyright figures (such as cartoon figures) may be used, unless written permission is acquired.
10. The banner must be designed and constructed solely by the participants. Any assistance offered by adults must be supervisory or consultative only.
11. Banners will be evaluated and rated based on the following:
 - Content – best portrayal of group
 - Creativity – originality, materials, enhancement
 - Construction – detail, layout
12. Banners submitted must have never been previously entered into convention competition.
13. Banners should remain on display until the posted time on Saturday. Groups are responsible for picking up their banners. Items left behind will usually be discarded in the trash by the hotel staff.
14. Banners may be made from any one or multiple types of materials.
15. Refer to the Evaluation Forms section of this rulebook to see the forms that will be used by the judges in this event. This will help the student in preparation for the event to see exactly what the judges will be looking for.

Judging

1. In addition to the event rules above, banners will be judged according to the Convention Rules and the official Banner Judge's Sheet.
2. Three to five judges will work independently to examine and score each banner entry. The combined rankings of all the judges will determine the winners.
3. For more information on serving as a judge, check out the informative videos on our website here - <https://www.lads2leaders.com/judges-training>

Awards

Awards for first, second, and third place teams will be given.

- The Art Gallery concept that encourages people to view the students' entries has been expanded to allow more time to view the art and reduce the crowd from all being in the room at one time. The room will open after judging is completed. It will remain open for approximately 24 hours. This will allow for more time to view the entries without being rushed.
- Additional signage will be used to make locating the items easier.
- In order for as many people as possible to see the entries, we ask that students leave their artwork in place until close to the posted closing time on Saturday.
- There will be a list of place winners posted in the Art Gallery Room where the entries are displayed. Another list will be posted at the Information Booth.
- Additionally, each of the entries that place in the top three and all finalists will be marked with a small ribbon placed on the entries at the conclusion of judging. This will allow those viewing the entries to know which ones placed, as well as giving photo ops with the students and their entries at their convenience. You can share these photos on Instagram or Facebook using the designated hashtag for the year so that we can possibly use them on the screens before the awards ceremonies.
- The final procedure for presenting the actual ribbons is still being finalized, but all award winners will be called to the stage in groups to receive their ribbons and have photo opportunities on stage.

Judges' Instructions for Banner Event

1. A banner will be disqualified if it does not include the L2L name or "Flying L" logo.
2. Banners will be judged in three major categories: Content, Creativity, and Construction. A maximum of 25 points may be given in each category by each judge.
3. Category definitions:
 - Content – best portrayal of group
 - Creativity – originality, materials, enhancement
 - Construction – detail, layout
4. Penalties
 - Disqualification – not including L2L name or the "Flying L" logo in the design
 - Incorrect size – (-10) over maximum size
 - Identification – (-15) not identifying the group on banner
 - Late entry – (-10) banners turned in after the deadline
 - Copyright – (-10) not providing authorization for use of copyrighted material

Bartimaeus

This is a non-competitive event.

Purpose

To provide an opportunity for students and adults with special needs to give a speech, lead a song, or read from the Bible in a non-competitive, friendly environment.

Event Participation

Participation in Bartimaeus events is strictly voluntary and is open to anyone of any age.

Event Rules and Guidelines

There are four different areas for Bartimaeus participation: Oral Bible Reading, Art Says It, Speech, and Song Leading (males)/Songs of Praise (females). When girls' Oral Bible Reading, Speech, and Songs of Praise are taking place, only other females may be in the room. See page 94 for more information on this L2L policy. All stated rules and guidelines in the Event Guidebook for these events are in effect for the Bartimaeus events, with the exception of the following:

1. Oral Bible Reading

- No minimum time limit – maximum time remains at 2 minutes.

2. Art Says It

- Artwork will be placed on a table for display only in the area where all artwork is displayed.

3. Speech

- Speeches should be no more than 3 minutes in length for all ages.

4. Song Leading/Songs of Praise

- Either one or two verses of a song may be led.

Evaluation

While the participants are not competing for place awards, there will be adults in the room serving as moderators and encouragers. They will provide positive feedback to the participants after completion of their events.

Encouragement and applause are to be expected in the Bartimaeus events.

Awards

Each participant will receive a certificate at the conclusion of each event in which he/she participates. During the awards ceremony on Saturday night, all Bartimaeus participants will be recognized and presented with an award on the stage. Each participant will receive only one Bartimaeus award, regardless of the number of events in which he/she participates.



Bible Bowl Team

Purpose

To enable participants to enhance knowledge of textual content; to develop quick reference to Bible facts and gain knowledge of Scripture; to bond through team spirit.

Event Participation

1. It is very important that participants, parents, coaches, and judges watch the Event Training and Judging Videos on the L2L website under the Convention tab.
2. Teams may participate in the following divisions:
 - Grades 3-4
 - Grades 5-6
 - Grades 7-8
 - Grades 9-10
 - Grades 11-12

Criteria for teams are as follows:

- a. Participants may participate on only one Bible Bowl team.
 - b. Team members may be boys and girls from grades K–12. However, no more than two students younger than third grade should be on one team. The youngest grade division for any team will be 3-4.
 - c. Students may not participate below their grade, but may participate in a division above their current grade.
 - d. A team consists of four participants – no more and no less. If there is an emergency before or during the Bible Bowl event and an alternate team member is necessary, the team leader may select any student from the congregation to fill in as long as the person is age appropriate. The student chosen does not have to be one that took the Bible Bowl test. However, substitution of team members for any non-emergency reason is not allowed once the Bible Bowl event has started. For example, a team that has an extra student serving as an alternate may not substitute that student for another at a break in the event just to have all students participate at the convention. The number of trophies and other awards that are in place are based on four-person teams. Extra awards for alternates may be requested after the convention from the National Service Center. **NOTE:** If a group does not have enough students for a full team, they may complete a request form on the L2L website: <https://www.lads2leaders.com/bible-bowl-and-debate-team-requests> to get assistance in completing their team.
 - e. A congregation may have any number of teams.
3. Questions will be worded from the New King James Version, stating the specific chapter and verse. Study materials may be ordered from the National Service Center. Bible Bowl study questions are available in Word and PowerPoint formats.
 4. Rules for Oral Rounds at Convention
 - a. All teams properly registered by the published registration deadline will participate in the oral rounds at convention. The eight “finalist” teams will be determined from the team scores during the oral rounds. The finalist teams will be called by name to the stage during the awards ceremony. The three top-scoring teams will be announced and receive their awards. The remaining finalist teams will receive their awards as they exit the stage. **NOTE:** Questions for the written test and oral rounds at convention may be taken directly from the study questions, rephrased study questions, or completely new questions.
 - b. Questions will be multiple choice and are to be answered by each team member, as follows:
 - A set of answer cards (“A,” “B,” “C,” “D”) will be provided for each team member. Each team member will display their answer card when called by the person reading the questions. Team members may not confer with one another.
 - One point will be assigned for each correct answer.
 - c. Teams must be ready to participate in the final rounds. If all members are not present when called, the team must participate with those who are present. Late participants will be seated promptly after they enter the room.

However, a question in progress is not to be interrupted to seat late team members. An absent team member will receive a score of zero for unanswered questions. If an alternate is used, he/she must remain as part of the team throughout the oral rounds. The late student cannot take the place of the alternate when he/she arrives.

- d. Grades 3-6 will answer 40 total questions. Grades 7-12 will answer 60 total questions.
 - e. The teams and the audience will face the reader and scorekeeper.
 - f. Computer projector(s) will be used to show the questions and answer choices on a large screen. Questions will be read aloud only one time.
5. Instructions for Tie-Breakers: At the end of 40 questions for grades 3-6 teams or 60 questions for grades 7-12 teams, there must be clear first, second, and third place teams. This means that the scores must be different for each of the top four scoring teams. If any of these teams has the same score, a tie-breaker is required. Additionally, the scores for the teams in eighth and ninth places must be different. If they are the same, a tie-breaker is required. The scores for teams in places four through eight may be the same as long as third is different than fourth and eighth is different than ninth. In the event that a tie-breaker is needed, all teams are to remain in place and answer all questions until the tie is broken. However, the answers for the tied teams are the only ones that are taken into account. Do not announce which teams are tied so that teams can be surprised when they are called to the stage during the awards ceremony.
- The tie-breaker will be a “sudden death” rather than a sum total based on a series of questions. The person serving as the “lead judge” over the teams that are tied needs to know which specific teams are tied. As the teams are re-seated for the tie breaker, the lead judge needs to look carefully to know where the tied teams are sitting. There are tie-breaker questions included with the oral round questions, so the reader will continue in the order of the questions in the same way that the other questions were read. When the students are instructed to show their answers, the adult scorers will note the answers at the bottom or side of the score sheets where there is space. When the correct answer is given from the reader, the scorers will hold up their hand indicating the number of correct answers from their teams. The lead judge will look at the judges to see if the tied teams had the same number correct, or if one of the teams got more correct answers. If the tie is broken, the Bible Bowl is over. If the teams are still tied, continue in the same manner until the tie is broken.
6. More information on this event and others, check out the videos on our website here - <https://www.lads2leaders.com/training-videos>

Judging

The following adult roles are necessary to conduct the oral rounds (NOTE: Groups must provide at least one judge per registered team):

1. **READER:** responsible for reading the questions in the oral rounds; should have a strong voice and feel confident with pronunciation.
2. **SCORE KEEPER (one per team):** responsible for recording individual responses and calculating team scores; should feel comfortable with math (would be advised to bring a pocket calculator).
3. **ROOM MONITOR:** responsible for limiting the distractions, either from individuals entering and leaving the room or from the audience. Holds everyone in place until the event is completed.
4. **ROOM LEADER:** responsible for checking the room prior to the oral rounds to ensure that all materials (score sheets and answer cards) are ready; during the event will help resolve questions which may arise. Verifies team scores and completes the winner’s list.
5. **JUDGES:** are given the authority to dismiss from the room any adult, student, or audience member who chooses to participate in cheating or inappropriate behavior. **WINNING IS NOT AS IMPORTANT AS HONESTY AND INTEGRITY.**
6. For more information on serving as a judge, check out the informative videos on our website here - <https://www.lads2leaders.com/judges-training>

Awards

First, second, and third place group awards will be given to the winning teams, along with individual awards for members of those teams. Finalist teams not placing in the top three will be recognized and presented with finalist awards. Only active team participants will receive an award at convention. If a team with alternate members wins an award, the congregation may purchase additional awards through the National Service Center for these members after the convention.



Oral Bible Reading

This is a non-competitive event.

Purpose

To emphasize the fundamental importance of Bible reading and to strengthen the foundation for public speaking. Bible reading is an important skill for young students to develop – the younger the better. Beyond the fundamental importance of reading the Bible, the skill of oral reading is also a foundation for other public speaking.

Event Participation

1. Students in Pre-K through sixth grade may participate.
2. Students in Pre-K through second grade will not be rated.
3. Since Oral Bible Reading is an entry-level event to get students accustomed to being in front of a group of people, there will now be a one-time exception made for students older than grade 6 who are part of a new group or are new to the program themselves. Each request for a student older than grade 6 needs to be sent to the L2L National Service Center by email at l2l@lads2leaders.com for review and approval. Only the National Service Center staff will be able to register students older than grade 6 for Oral Bible Reading. All students older than grade 6 will participate in the event room assigned for grade 6 in the convention program.
4. Lesson 7 in the *Field Book of Leadership: Revised* provides basic instructions on Oral Bible Reading. The *Field Book of Leadership: Revised* may be ordered by calling the National Service Center or by shopping in our online store.

Event Rules and Guidelines

1. Readings may be taken from either the Old Testament or the New Testament. Any standard translation may be used. No paraphrase Bibles may be used. Reading may be done from electronic handheld reading devices.
2. The Scripture reading may not be less than one minute nor more than two minutes in length.
3. No males will be allowed in the rooms where girls are participating in Oral Bible Reading. See page 94 of this rulebook for more information on this L2L policy. This policy does NOT restrict a mother from bringing her infant or toddler son into a girls' event room.

Judging

1. The reading of Scripture will be judged on a one-to-three basis of: Excellent (3); Good (2); and Needs Improvement (1).
 - Rating Sheets completed by the judges will be given to the participants.
 - Ratings will be: AAA, 14-15 points; AA, 11 to 13 points; and A, 10 points and below.
2. Participants will be evaluated on the following criteria (see Evaluation Forms section of this rulebook for the rating sheet to be used at convention):
 - The Scripture reading may not be less than one minute nor more than two minutes in length. Students will be penalized one point for one to 30 seconds under one minute or over two minutes; two points for 31 to 60 seconds under one or over two minutes; etc.
 - The reader will be judged as to neatness and appearance. "Sunday dress" is expected for this event. However, no stringent dress code has been adopted. A boy will not be penalized for not wearing a coat or tie. Grooming and neatness are important in appearance.
 - Poise and posture while reading will be rated.
 - Enunciation, voice, and articulation will be rated.
 - The effectiveness of the participants in the identification of the passage and translation will be rated.
 - The appropriate voice volume for the room used will be rated.

Awards

1. Rating sheets and certificates of participation will be given to each participant based on the above ratings.
2. Readers below third grade will not be rated but will receive a certificate of participation.



Debate

Purpose

1. To promote deeper study of Scripture as it relates to life's issues.
2. To promote development of a deeper understanding of both sides of a debate issue.
3. To promote the participant's ability to follow standards of procedure, to keep the discussion within bounds and ensure a fair hearing to both sides of a debate issue.
4. To improve skills in unrehearsed or improvised speaking with little preparation, so that participants learn to think on their feet and adapt their presentation to that of their opponent.
5. To promote research and understanding of questions that may arise regarding the debate issue.
6. To develop the following skills in critical thinking:
 - Understanding and application of the principles of logical reasoning in a debate setting.
 - Judgment or insight regarding a debate proposition.
 - Discovery of facts related to a debate issue.
 - Ability to research and study a subject.
 - Knowledge of the proof requirements of a proposition, including one or all of the following: examples, common sense, expert opinion, facts, scriptures, and statistics.
 - Ability to apply the tests of evidence.
 - Judgment or insight between valid and false reasoning.
 - Judgment or insight regarding false assumptions.
 - Recognition of non-legal persuasion.

Event Participation

1. Students in grades 7-12 may participate.
2. Two debaters (two boys together or two girls together) are required to form a debate team. Individuals who need a partner may contact the debate coordinator of their convention using a form that will be on the L2L website: <https://www.lads2leaders.com/registration> The debate coordinator will attempt to match up teams from such individuals, but Lads to Leaders cannot guarantee that such a match will be possible. A student may debate as a single debater against either a two-person team or possibly another single debater, if they choose to register as a single or are unable to find a partner. **IMPORTANT NOTE:** A group will be allowed **ONLY ONE** single debater to be registered for the boys' debate or the girls' debate. Students may not opt to debate alone if there is another student is not willing to be their partner.
3. Boys and girls will debate separately. There will be no mixed teams, and no males will be allowed in the rooms where girls are debating. See page 94 of this rulebook for more information on this L2L policy. This policy does **NOT** restrict a mother from bringing her infant or toddler son into a girls' event room.
4. All students should study the *L2L Speech & Debate* book and lesson 13 of the *Field Book of Leadership: Revised* to develop their debating skills. Both may be ordered by calling the National Service Center or by shopping in our online store. It is very important that participants, parents, coaches, and judges watch the Event Training and Judging Videos on the L2L website under the Convention tab.

Event Rules and Guidelines

1. The debate resolution may be either a policy or a values resolution. In values debate, the affirmative team argues for the proposition, while the negative team challenges the proposition. In policy debate, the affirmative team argues for the adoption of the resolution as policy, while the negative team argues against its

adoption. The resolution may also be a truth/error topic such as baptism.

2. Teams: Each debate round will be between two teams of two speakers each. Each team will participate in two rounds, one on the affirmative side and in the other on the negative side. For single debaters, that student will present both speeches that would typically be presented by the two separate students. For example, if Johnny Smith is a single debater and has the Affirmative position, he will present both Affirmative Constructive speeches and both rebuttal speeches as shown in the list below and the diagram on a following page. The length of the debates will be the same whether the teams have one or two team members.
3. Seating: The following diagram indicates the location of principal participants in the debate.

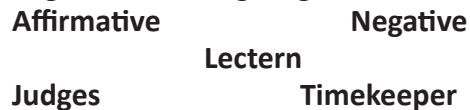

4. The following schedule is to be used (this entire arrangement represents one round):

- First affirmative constructive 5 minutes
- First negative constructive 5 minutes
- Second affirmative constructive 5 minutes
- Second negative constructive 5 minutes

Five (5) minute break between constructive speeches and rebuttals.

- First negative rebuttal 3 minutes
- First affirmative rebuttal 3 minutes
- Second negative rebuttal 3 minutes
- Second affirmative rebuttal 3 minutes

A flowchart example of this schedule follows this section.

5. **First affirmative constructive:** States a reasonable interpretation of the resolution, and represents prima facie case for the adoption of the resolution (a case which, if not challenged, would lead a reasonable man to support the resolution). A summary of what the second affirmative will present may also be included. The affirmative team has the burden of proof in favor of the resolution.

First negative constructive: Offers arguments against the adoption of the resolution, and may respond directly to the first affirmative. The negative team must either use the affirmative team's interpretation of the meaning of the resolution, or else show that interpretation to be unreasonable. The negative team must disprove the resolution.

Second affirmative and negative constructive: Complete the constructive arguments of the respective teams, and present a brief summary of the team's position. These speakers may also offer refutation of previous speakers.

Rebuttal speeches: Rebuttal speeches focus the debate on contested issues, as the speakers attack opposing arguments and defend their own. No new issues or arguments may be brought up in rebuttal speeches, but new evidence may be introduced to support or refute any claim introduced in any constructive speech.

6. **Visuals:** Any visual aids used in the debate must be visible to both teams and the audience and must be left available for reference by later speakers. Posters or charts are to be left on display throughout the debate following their introduction. Electronic visual aids must be battery operated.
7. The use of electronic handheld reading devices is allowed for the purpose of reading scripture and/or lesson notes ONLY. The sound must be turned off. They must not be able to access the Internet. Electronic communications with other individuals inside or outside the room is prohibited during the debate.
8. The L2L National Service Center has research materials, books, and pamphlets available to assist with the study and preparation for Debate. Contact the office for details.
9. Refer to the Evaluation Forms section of this rulebook to see the forms that will be used by the judges in this event. This will help the student in preparation for the event to see exactly what the judges will be looking for.
10. More information on this event and others, check out the videos on our website here - <https://www.lads2leaders.com/training-videos>

Judging

1. One of the judges, previously designated as the room chairman, will preside over the debate. His duties include:
 - To briefly welcome those present.
 - To ascertain that a timekeeper is present and ask for a volunteer, if necessary.
 - To ask the speakers to introduce themselves, by name only, with no identification of their congregation or hometown.
 - When all judges, the timekeeper, and participants are ready, to call for the debate to begin.
 - When time is up on the last speech, to announce the end of the debate and to thank the speakers, timekeeper, and audience, but not to announce the judges' decision on the debate.
 - To take charge of the judges' score sheets and deliver them to the debate coordinator following the event.
2. Timekeepers
 - The timekeeper will be a volunteer from the audience, or, if necessary, one of the judges may also keep time.
 - The timekeeper will display silent signals for each minute of elapsed time, and an audible signal will be given at the end of each speaker's allotted time. When the timekeeper signals that time has expired, the speaker should stop speaking or otherwise be subject to penalties.
3. Penalties
 - Speakers will be penalized one point for each new issue introduced in a rebuttal speech.
 - Speakers will be penalized one point for each 30 seconds or part thereof over the time limit.
4. For more information on serving as a judge, check out the informative videos on our website here - <https://www.lads2leaders.com/judges-training>

Judges' Instructions for Debate

1. Use one Debate Team Score Sheet for each team for the whole debate.
2. Write the speakers' names in the spaces provided.
3. Circle whether the team is on the affirmative or negative side.
4. Assign a numerical value 1-10 (10 being best) to each category covered on the form.
5. At the end of the debate, total the number of points for each speaker, deducting any penalties.
6. Transfer total points for individual speakers to the summary sheet.
7. Select the overall winning team in the debate. This should be the team which most effectively defended its assigned position on the resolution. It may or may not be the team with the most speaker points from the team score sheet. The winning team gets a 5-point bonus.
8. Add each team's total points, attach all score sheets, and turn in to the room chairman.

Awards

1. First, second, and third place awards will be presented to the highest scoring speakers.
2. First, second, and third place awards will be given to each member of the highest scoring teams.

NOTE: THIS IS A MOCK DEBATE. JUDGES ARE NOT TO LET THEIR PERSONAL VIEWS ABOUT TOPICS INFLUENCE THEIR DECISION FOR OR AGAINST ANY TEAM. SCORES SHOULD BE BASED ON THE EFFECTIVENESS OF THE DEBATERS.

The following flowchart illustrates how the debate will proceed.

For illustration purposes:

Team 1 is Bob & Steve

Team 2 is Joe & Andrew

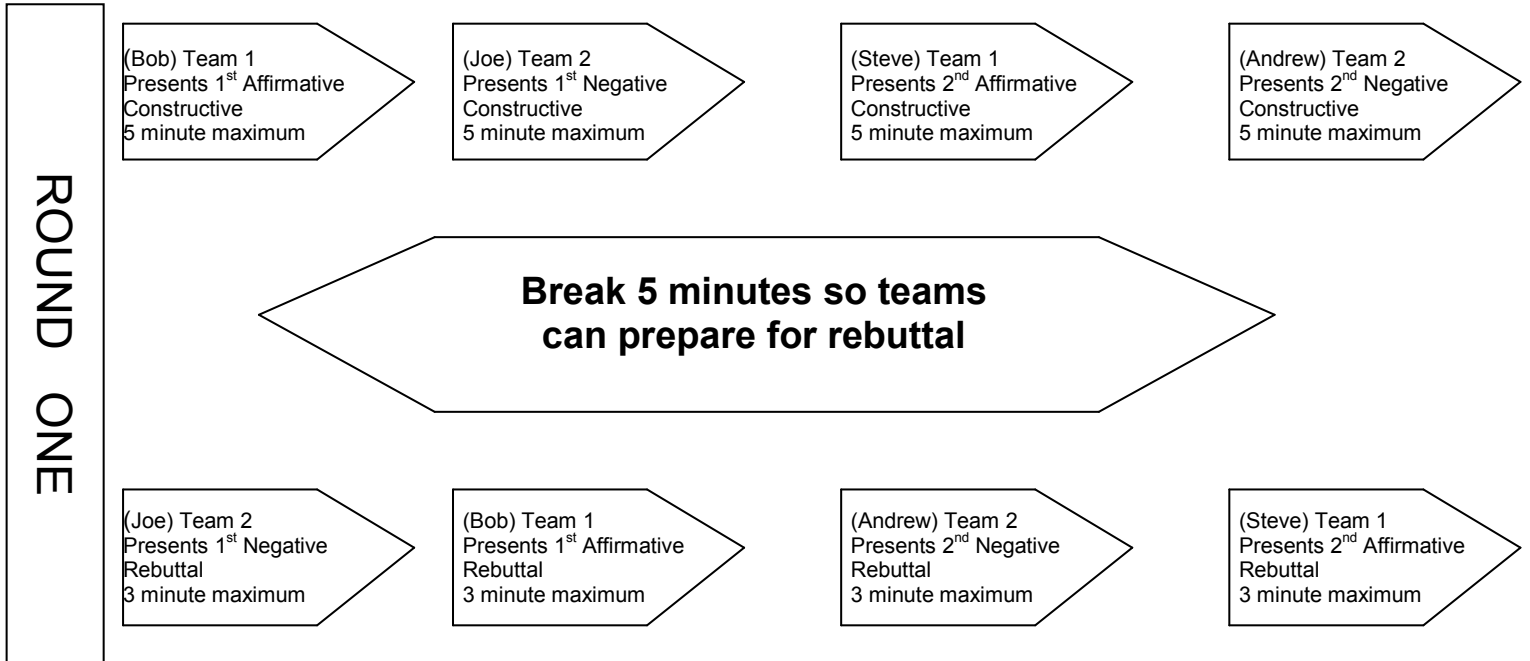

5 MINUTE BREAK BEFORE ROUND TWO

Note that Round Two may involve different teams than Round One.

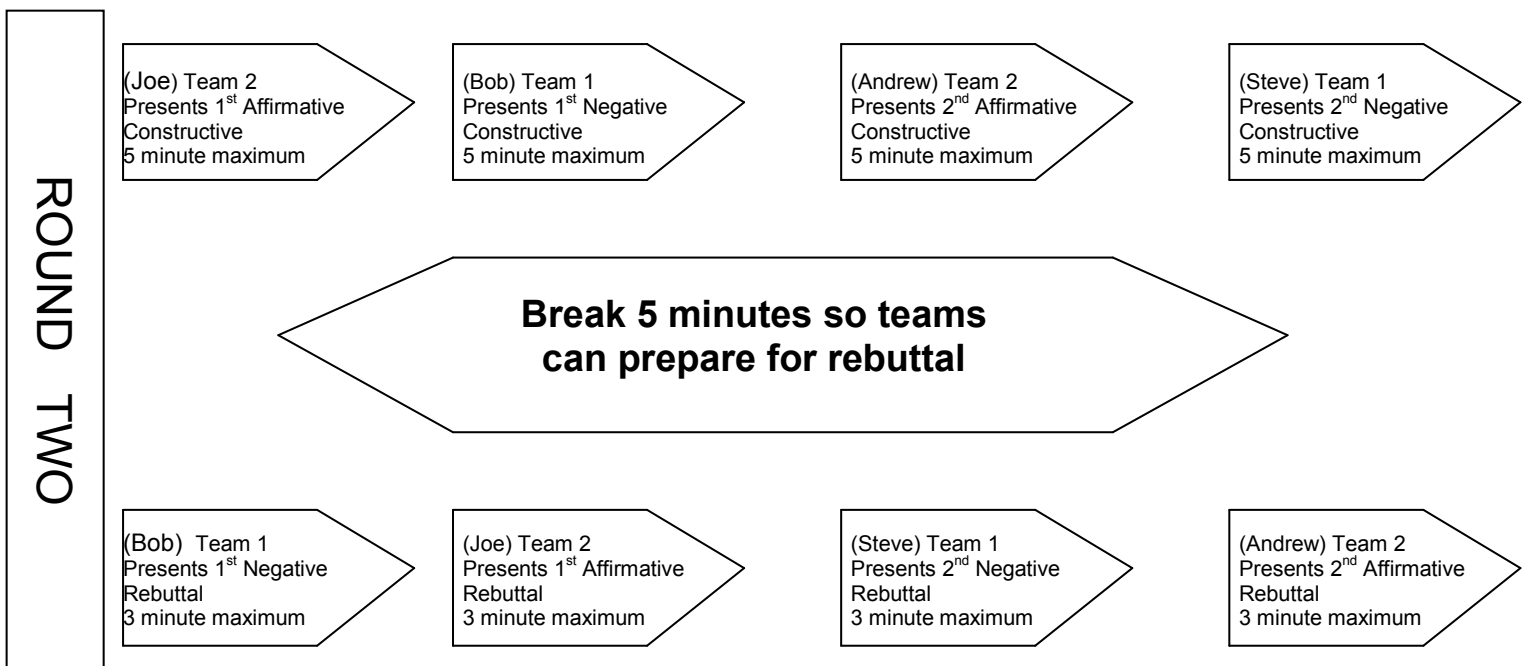

Host/Hostess

Purpose

To serve at the convention. Hosts and Hostesses are selected students who will show exceptional hospitality and will be friendly and helpful. They will greet, guide, assist individuals or groups, and will put a gracious touch to the convention. They are to give a warm, friendly attitude of “We are glad you are here” and “How can I help you?”

Selection Process

To be selected to serve as Host or Hostess is an honor. Hosts and Hostesses will be selected according to the following procedures.

1. Students may be nominated from any of the following applications.
 - Students wishing to serve must notify their group leader who can register them on the Convention Registration database.
 - Congregations may suggest specific students of outgoing personality and helpful nature.
 - National Service Center may submit names from workshops and scholarship applicants. National Service Center will refer names to coordinator.
 - Board members and coordinators may submit names to the coordinator of Host and Hostess.
2. From applicants submitted, students will be selected for the honor using the following criteria:
 - Considering the total number of applicants, a high percentage of seniors and juniors will be selected and a lesser percentage from grades 7-10.
 - Students must be available from Friday morning through the Saturday night Awards Ceremony. However, this will not take away from their own participation.
 - Students must provide a personal email address in their registration in order to directly communicate with their coordinator and/or convention director for purposes of RSVP and assignments. **DO NOT** enter the email address of the group leader or other person. It is imperative that the coordinator and/or convention director be able to communicate directly with the students.
3. The coordinator will send a response to all students who apply and request an RSVP by a specific date from those who are selected to serve. If no RSVP is received by the specified response date, the name will be dropped and another student will be contacted.

Guidelines

1. Availability
 - Be available for instructional meeting by coordinator Friday afternoon (time to be arranged).
 - Be available Friday morning through Saturday night awards on a rotational basis that the convention director or coordinator will set. This is not to cause any problems with students’ personal events.
 - The coordinator will make every effort to work with coordinators of other events, staff members, directors, and students to match their availability to the requirements of the coordinators, staff, and directors.
2. Dress
 - Group Leaders: Make sure your participants are dressed properly - modestly and appropriately. It is a positive or a negative reflection on your congregation. Attire for Friday-Saturday during the day: church attire, pantsuits, sport coats, etc. (no t-shirts, jeans, or shorts).
 - Attire for awards ceremonies: Sunday church attire, informal or formal. **No strapless, spaghetti straps, too low cut, short or tight dresses. Remember that you represent Christ and His Church. Students are encouraged to look their best as Christian examples. Students dressed immodestly will be dismissed from their service.** While a participant’s presence may complement an event, it is not to be a distraction. The dress code **WILL** be enforced.
 - Some convention locations may require a “uniform” for Hosts/Hostesses to help identify them and make it easier for people to get assistance from them as needed. This will be at the discretion of the convention

director for each location. The convention director or Host/Hostess coordinator will communicate in sufficient time for the student to acquire the needed items. The uniform will consist of an L2L polo shirt that will be purchased through L2L and khaki slacks (or skirt of at least knee length for girls, if preferred over slacks). The director or coordinator will let the students know if specific colors are required. For example, Atlanta has Red and Blue color divisions, so the shirts will match the color division of the student's group.

3. Assignments

- Assignments will vary and will be made by the convention director and/or event coordinator. If more students have been assigned to a post than needed, communicate to the Host and Hostess coordinator because there may be a shortage elsewhere. If stationed by an awards stage, do not block the view of the audience or photographers. **Hosts/Hostesses will NOT be on stage for any assignment.**
- Examples of Host/Hostess assignments include, but are not limited to: runners for Art, Banner, Scrapbook coordinators; door greeters for awards ceremonies; assist with going on and off stages; information booth help; and other needs as they may arise.
- Whatever the assignment, make it a service of joy by meeting new people and making them feel comfortable. Some assignments may be:
 - Greet people as they arrive and ask if you can help them.
 - Assist at the awards ceremonies as needed.
 - Guide people to various events and around the hotel.
 - Be able to answer questions.

Parade of Leaders

Purpose

To recognize those young people selected for their leadership qualities to represent their respective groups. The parade is the kickoff for the Friday evening awards ceremony at convention. Two students will be chosen to participate in this Parade of Leaders. Students may be chosen by group leaders or peers. Students must carry either a poster, pennant, or sign to identify their congregation. Please check the convention schedule for parade assembly time and location. Students selected to represent their home congregation should view this as a great honor. The names of the students chosen do not need to be turned in to the National Service Center.



Puppet Theater

Purpose

To train students to teach children biblical principles using puppets. Participants learn valuable team-working skills in their preparation and presentation. Great opportunity for participants to gain self-confidence in public presentations.

Event Participation

Performances will be held in the following divisions. The team must participate in the division of the oldest member. Students may participate on only one puppet team. Students in grades Pre-K-2 may participate on third grade or older puppet teams.

- Grade 3
- Grade 4
- Grade 5
- Grade 6
- Grade 7
- Grade 8
- Grade 9
- Grade 10
- Grade 11
- Grade 12

Event Rules and Guidelines

1. A team may consist of no more than 12 members.
2. Puppet shows must adhere to the announced Convention theme and teach a biblical message. The message being taught is more important than the performance.
3. No team is to use the name or use any sign that would identify its congregation.
4. Each grade division will participate in a different room.
5. Representatives from each congregation should report to the registration area on Friday morning to obtain a performance time for each team, if not already received by email, and to verify that the required number of judges will be present at the judges' meeting. NOTE: Special requests for performance times will be considered by the Puppet Theater Coordinator, but are not guaranteed. Please provide the reason for the request when submitted. Only requests received by the posted convention registration deadline will be considered. Times will be sent to the Puppet Theater coordinator for each group that provides an email address in the convention registration system. Otherwise, they will be sent to the Team Leader.
6. Teams CANNOT practice on stages at the convention. Team captains can inspect their performance room, but cannot alter the stage setup. Report any problems to the puppet coordinator.
7. The puppet team must be at the performance room at their designated performance time. Failure to be at the room on time may result in disqualification.
8. The timekeeper will announce teams to perform by letter designation at the time of performance.
9. After announcement, each team will have a total of 12 minutes to set up, present puppet show, remove all equipment, and exit the room.
10. The stage area must be left as it was found (i.e. four chairs in front area, walkboard in rear area, and curtains back in place). A penalty of two points will be deducted from each judge's sheet for failure to do so.
11. The team captain or adult leader must state "we are clear" or "clear" as the final team member exits the room, and the timekeeper will stop the stopwatch. When the last person exits the room, the time will be stopped - regardless of whether the clear statement is made or not.

12. The timekeeper will give an oral warning at the 10-minute mark of the performance – meaning there are only 2 minutes left without penalties.
13. The puppet show (actual performance) must be a minimum of five minutes. Groups will be penalized two points for one to 30 seconds under five minutes; four points for 31 to 60 seconds under; etc.
14. Adult leaders may assist in set-up and take-down. However, all adults must clear the stage area during the performance.
15. Electronic devices may be used for special effects. However, students must use their voices for puppets. Pre-recorded script dialogue will not be permitted. Instrumental music **MUST NOT** be used for “church” or “religious” songs. It is recommended that musical instruments not be used even for secular songs. However, groups that choose to have musical accompaniment for secular songs will not be penalized. Special effects must not overshadow the message.
16. All special effects (lighting, sound, etc.) must be controlled by team members rather than adults. The lights in the performance rooms **CANNOT** be turned off during any part of a performance. This is because not all rooms have independent controls, and the judges need to be able to see to make notes and score the performances. One narrator per puppet team may be used but must be in the same age division as the team. The narrator may stand to the side or front of the stage or may choose to be behind the curtain using a puppet.
17. All stage props **MUST** be within the dimensions of the stage or attached to the stage. No attachment should extend more than 12 inches beyond the frame of the stage, and must be attached to the frame at all times. No electrical power cords (extension cords) are allowed to extend from wall outlets to the stage/prop area.
18. Public address systems will not be provided or allowed. CD players may be used but will not be provided. They must be battery-powered.
19. Four standard chairs will be provided in the front stage area and a walkboard (measuring 2” x 10” x 8’) in the back stage area. These items may be removed if a team does not wish to use them; however, they must be returned when the team is finished. Any adjustments, such as these, must be made during the 12-minute show time.
20. Any congregation having three or more participating teams must provide at the convention site a stage and walkboard built to the specifications outlined later in this section. Indicate in your group’s online registration how many stages you are willing to bring to convention. **PLEASE ENSURE THAT YOUR STAGES ARE BUILT TO THE SPECIFICATIONS IN THIS Event Rulebook.** If possible, build an adjustable stage that can be used for either the younger or older teams. The national puppet coordinator will be in contact with those congregations to make arrangements for setup at the convention site.
21. Puppeteering is not part of the worship service.
22. The target audience for Puppet Theater is children.
23. Refer to the Evaluation Forms section of this rulebook to see the forms that will be used by the judges in this event. This will help the student in preparation for the event to see exactly what the judges will be looking for.

Judging

1. Judges must be knowledgeable of the rules for this event. Each congregation **MUST** supply at least one judge per team. Register the judges in the convention registration system. Judges should be selected from those who are not directly working with a puppet team because team (Red, Blue, Green, etc.) performances are simultaneous.
2. Each room of participants will have a minimum of three judges. A separate timekeeper will be in the room when a sufficient number of judges are registered. Otherwise, one of the judges will also serve as the timekeeper.
 - Judges may not score their own team.
 - Judges must use the official score sheet provided.
3. Score sheet terms explained:

- Creativity – Using original ideas, costumes, effects, teaching methods.
 - Based on Convention Theme – Play must be based on the announced convention theme.
 - Biblical Message – Does it teach a biblical message?
 - Animation – Does the movement of puppets’ mouths match the dialogue? Do the puppets have good position? Can the puppets be seen or are they sinking too low? Are puppeteers hidden, or do you see tops of heads? Are the entrances and exits done smoothly? Do the puppets look natural?
 - Sound quality – Are the puppeteers speaking loudly enough to be heard? Are the words clearly enunciated?
 - Special effects – What is the quality of the props? Do the props and special effects enhance or detract from the play? Are the special effects excessive and take away from the Bible message?
 - Teamwork – Was the set up and take down smooth? Was there excessive noise or activity behind the stage not relating to the play? Do puppets relate to each other during the script (looking at who is talking, etc.)?
 - Overall Impression – Appeal, impression, biblical message.
 - Penalties – Each team will have a total of twelve minutes for set-up, show, and take-down. Groups will be penalized two points for one to 30 seconds over 12 minutes; four points for 31 to 60 seconds over; etc. The “message” or show must last at least five minutes. Groups will be penalized two points for one to 30 seconds under five minutes; four points for 31 to 60 seconds under; etc. Self-identification will be penalized 10 points. Special effects that detract from the message will be penalized 10 points. Risqué or inappropriate language or inappropriate humor will be penalized 10 points.
4. For more information on serving as a judge, check out the informative videos on our website here - <https://www.lads2leaders.com/judges-training>

Suggestions

1. Remember team effort. Teamwork is important – leaders must work together as a team.
2. The biblical message should be clear and not lost in the theatrics.
3. Practice the complete program, including set-up and take-down.
4. Everyone has a job and must realize the importance of his/her responsibility.
5. If more than one team is competing in different divisions, it would be advisable to have puppets for each team. Problems may result if two teams sharing the same equipment are scheduled at the same time. There is not a guarantee that special schedule requests can be honored.
6. It is best not to make props exactly the width or height of the stage. Some stages may vary slightly. Make props with hangers large enough to go over a 1-1/2” pipe and thick curtain.

Awards

1. Team awards will be presented to the first, second, and third place winners in each division.
2. All participants on the winning teams will receive individual awards.

Building a Puppet Stage

Basic Parts List:

- Puppet Stage
 - 10 "T" connectors for 1 ½ inch PVC pipe
 - 8 90° elbow joints for 1 ½ inch PVC pipe
 - 8 10-foot long pieces of 1 ½ inch PVC pipe
- Bases
 - 6 10" x 10" x 1 ½" wood blocks
 - 6 Galvanized floor flange for 1 ½" PVC pipe
 - 24 1 inch #12 flathead screws for securing flanges to wood blocks
 - 6 1 ½" PVC pipe-threaded coupling
- Walk Board
 - 1 10-foot long 2 x 10
- Curtains
 - Dark material (must not be able to see through curtains) that is 60 inches wide by 20 yards long.

Cuts to be made to PVC pipes:

- Pipe #1 – Cut two pieces 49" long each, and one piece 17 ¾" long
- Pipe #2 – Cut two pieces 49" long each, and one piece 17 ¾" long
- Pipe #3 – Cut two pieces 43 ¾" long each, and two pieces 14 ½" long each
- Pipe #4 – Cut one piece 106" long
- Pipe #5 – Cut one piece 115 ½" long
- Pipe #6 – Cut one piece 106" long
- Pipe #7 – Cut one piece 85" long and one piece 30 ¾" long
- Pipe #8 – Cut one piece 85" long and one piece 30 ¾" long
- From the scrap pieces, cut eight pieces that are 2 ¾" long each

Dimensions for 3rd and 4th Grade Puppet Stages

The cuts listed above and the instructions on the following pages are for stages for 5th grade and older teams. Stage height for 3rd and 4th grades is reduced by 12". Front tier will be 3' 6"; middle tier will be 5'; and back tier will be 6' 6". To account for this difference, if you intend to build a stage for the younger kids, make the following adjustments to the cuts: Pipe #1 and Pipe #2 – change 49" pieces to 37" pieces (2 front and 2 middle posts); Pipe #7 and Pipe #8 – change 85" pieces to 73" pieces (2 back posts). All other cuts and instructions will be the same. The dimensions for the front curtains and the back, side curtains will be reduced by 12" each to 42" and 78", respectively. The middle and back tier curtains will be the same measurement for both size stages.

It is highly recommended that groups build adjustable stages that can be used for any age team. To do this, build a stage to the dimensions listed above for 3rd and 4th grade teams. Then purchase six (6) straight PVC couplers to join two pieces of 1 ½" PVC pipe. Since the length of the couplers may vary, we will not provide specific lengths for the additional pieces of PVC pipe needed to raise the stage to the height required for the older teams. Cut the pieces so that when inserted into the coupler and then added to the legs of the stage, the entire stage is raised by one foot to the height shown on the drawing that follows these instructions. It is recommended that screws are used at the coupler joints for added stability. For adjustable stages, the curtains should be made to the longer specifications. They can either be pinned up when the stage is shortened or left long.

Assembly Notes and Suggestions:

- Use 1 ½" PVC pipe for stage.
- Make sure that all cuts are square to ensure accurate dimensions. Either use a power miter saw or a miter box and hack saw.
- Glue the joints where the 2 ¾" pieces were used to keep from losing the small pieces when stage is disassembled. It is recommended that the other joints not be glued so that stage can be easily disassembled for transporting. Screws or holes with pins at the joints will make the stage more sturdy during use.
- After initial assembly, use a permanent marker to mark the location of each vertical post (front right; middle right; etc.). Also, to aid in re-assembly, number each side of the joints that are not glued so that they can be matched up easily.
- Please note that the middle, vertical posts will not line up with the other two because of the offset from the 90° elbows.

Assembly Instructions:

- Attach the floor flanges to the center of the wood blocks. Screw the pipe-threaded couplings into the floor flanges to form the bases for each vertical post.
- Lay out the bases on the floor as shown in the diagram. Insert the 49" pieces (four totals) into each of the front and middle bases. On top of the front pipes, place "T" connectors with the long side parallel to the front. On the middle pipes, place "T" connectors vertically with the bottom of the "T" facing toward the front.
- Into the outside of each of the two fronts "T" connectors, insert a 2 ¾" piece of PVC. Onto those pieces, place a 90° elbow with the opening facing the back.
- Insert one of the 106" pieces into the inside openings of the front "T" connectors.
- Insert a 43 ¾" piece into the opening of the 90° elbow on the front corner and the T connector on the middle post. Repeat for other side.
- Insert a 14 ½" piece into the top of the "T" connector on the center post. On top of that piece, place a "T" connector vertically with the bottom opening of the "T" facing inside. Repeat for the other side.
- Insert the 115 ½" piece between the "T" connectors on top of the center posts.
- Insert 17 ¾" pieces into the top openings of the "T" connectors on top of the center posts. Place a "T" connector on top of each of these that is parallel to the sides.
- Insert the two 85" pieces into the back bases. Place a "T" connector on top of each of these with the long side parallel to the back.
- Insert the second 106" piece between the "T" connectors on top of the back posts.
- Into the outside of each of the two back "T" connectors, insert a 2 ¾" piece of PVC. Onto those pieces, place a 90° elbow with the opening facing the front.
- Insert a 30 ¾" piece into the back of the "T" on top of the middle post and into the opening on the 90° elbow. Repeat for other side.
- Into the front of the "T" on the top of the middle post, insert a 2 ¾" piece. Onto that, place a 90° elbow with the opening facing inside. Into the elbow, insert a 2 ¾" piece. Onto that, place another 90° elbow with the opening facing to the back. Repeat for the other side.

Walk Board Instructions:

- Cut an 8 foot length from the 10 foot board. From the remaining two feet, cut three pieces that are 6 ½" long each.
- Place the three pieces under the long board (one at each end, and one in the center) and secure with 3" wood screws.

Curtains:

- Dimensions for the cuts to the material to make the curtains are as follows (these dimensions allow for a 5 inch casing to go around rails and hem at bottom and sides):
- Front curtain – 60 inches tall by 233 inches wide. It will wrap from the middle post on one side around the front to the middle post on the other side. It needs to be one solid piece, no gaps. You will need an opening in the casing at each corner where the “T” connector will connect to the front vertical posts. Leave a gap in the stitching rather than cutting the material.
- Middle curtain – 42 inches tall by 131 inches by wide.
- Back curtain – 43 inches tall by 120 inches wide.
- Two back, side curtains – 96 inches tall by 47 inches wide. They need to go from the back vertical post past the center post and around the top, curved pieces. You will need an opening in the casing at the joint where the “T” connector will connect with the middle vertical post. Leave a gap in the stitching rather than cutting the material.

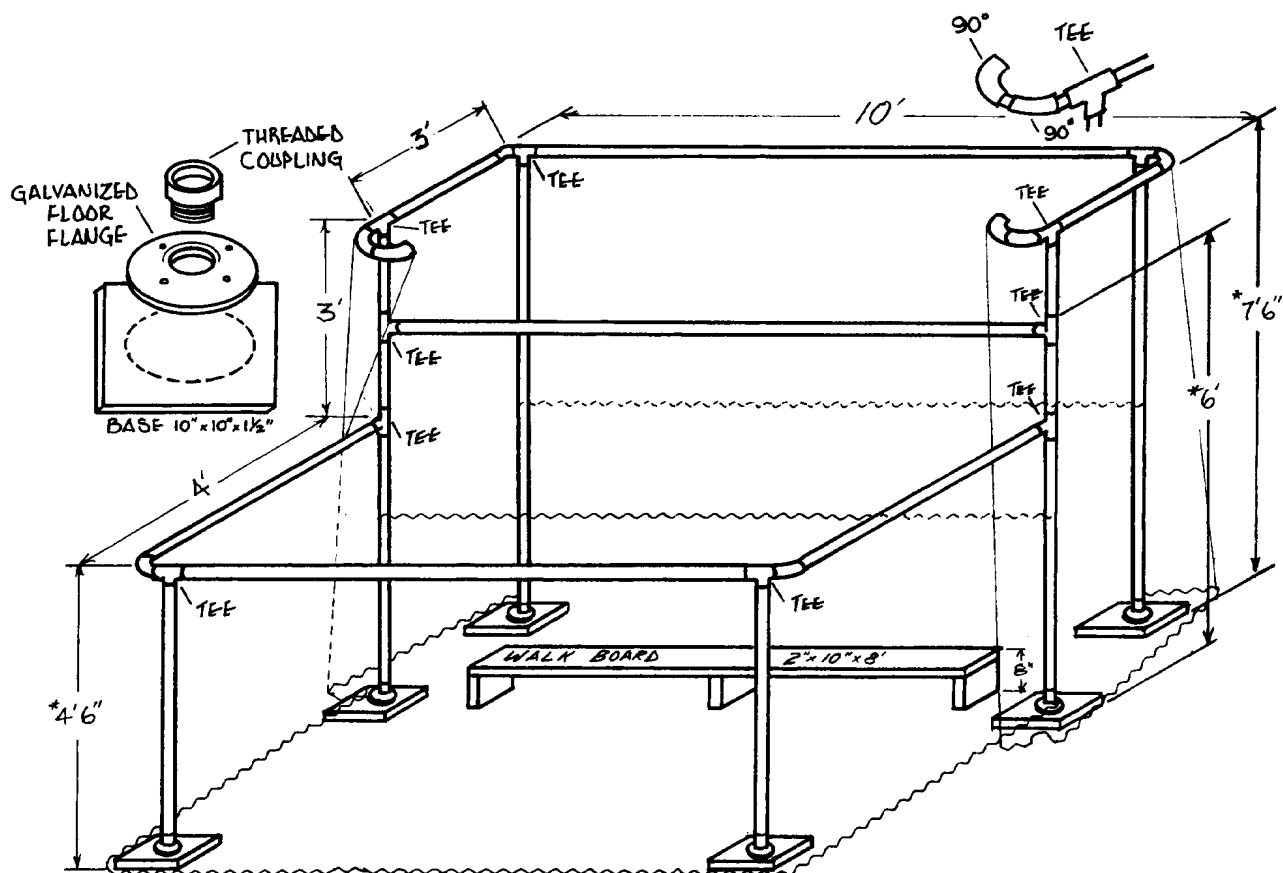



Scrapbook

Purpose

To serve as record of the activities and growth of students and groups. To provide a tool for recording the special achievements in the lives of the individual students and to document events and activities of the local church.

Event Participation

1. Individual Divisions
 - Grades 3-6
 - Grades 7-9
 - Grades 10-12
2. Group Divisions – Scrapbooks entered by L2L groups, except those that have won first place ribbons in previous conventions, are judged together. All groups that have won first place are judged in the Winners' Circle from then on.

Event Rules and Guidelines

1. Scrapbooks should pertain to L2L activities as well as personal growth and development during the **current** year (from last convention to present). First year scrapbooks may cover previous years. Twelfth grade participants may include previous years L2L activities. No special consideration will be given in judging first year or twelfth grade participants. These will be judged on merit as are those who cover only one year.
2. Individual scrapbooks must be the work of the student. While some adult guidance may be needed for group scrapbooks, the creativity and products of the scrapbook must be the work of one student or the collaborative work of a group of students.
3. All scrapbooks are to be **no smaller than 8 1/2 x 11 inches** and **no larger than 14 x 18 inches**.
4. Scrapbooks should contain a table of contents, a preface or introduction, and a conclusion. The year covered in the scrapbook should be identified. Organization is an important aspect in judging the scrapbooks.
5. The cover design of the scrapbook must have the following included in the cover design:
 - Name of the student or congregation.
 - The name Lads to Leaders/Leaderettes, L2L, or the "Flying L" logo.
 - The actual convention theme as published by L2L – no deviations or alternate interpretations.
6. All scrapbooks must be registered through online registration. This is necessary to adequately prepare for the event and for verification of Winners' Circle recipients from previous years. **Scrapbooks cannot be submitted at the convention unless they are registered.**
7. Scrapbooks must be received at the Scrapbook Registration Desk on Friday at the scheduled time. A completed **Scrapbook Official Entry Sheet** must accompany the scrapbook.
8. **When selecting pictures to include in your scrapbook, please do not use photos showing immodest dress (short shorts/skirts, swim suits/bikinis, etc.) or clothing with inappropriate images or words. Scrapbooks with inappropriate photos will be penalized ten points.**
9. Scrapbooks are not to be created/bound using online photo sites (such as, but not limited to, Flickr, Shutterfly, or Snapfish). They must be crafted by the participant(s).
10. Refer to the Evaluation Forms section of this rulebook to see the forms that will be used by the judges in this event. This will help the student in preparation for the event to see exactly what the judges will be looking for.

Judging

1. Groups must provide at least one judge per three registered scrapbooks. If less than three books are registered, a minimum of one judge must be provided.
2. Judging will be completed prior to the Friday evening assembly. Scrapbooks should remain on display until the posted time on Saturday. Groups are responsible for picking up their scrapbooks. Items left behind will usually be discarded in the trash by the hotel staff.
3. Judges are reminded not to reveal the results before the awards ceremony.

Criteria for Judging:

- Cover Design (10 points): Does the book conform to the specified requirements for the cover?
 - Table of Contents (10 points): Is a table of contents included in the book? Is it clear and concise? Does it help the reader understand the organization of the book?
 - Introduction/Organization/Composition/Construction (20 points): Does the book follow a natural sequence representing the last year's work? If this is the first scrapbook compiled by the individual or group, does it follow a natural sequence in showing their history of involvement in the program? Are activities and other items easily understood? Is the book well-made, or does it fall apart as it is viewed?
 - Appeal/Impression (15 points): Is the scrapbook appealing to the eye and easy to follow? Is it attractive? Too cluttered? This category includes layout, use of pictures, and the labeling of pictures.
 - Creativity (15 points): Is the scrapbook original and unique in the ways that ideas are presented?
 - Theme (15 points): Does the scrapbook reflect a theme throughout the book? The theme can be an idea such as kites, music, travel, etc. or the actual convention theme carried out through the entire book. The theme makes the scrapbook flow from the first page to the last page.
 - Conclusion, Summary, and Future Expectations (15 points): Does the conclusion briefly summarize the student's or group's year in the program as well as reflect their vision for the future?
 - Judges are to assume that the work is that of the student. Judges are not to be in the role of judging capabilities of the student. L2L promotes the honor system.
 - Judges will evaluate no more than 8 scrapbooks to allow for sufficient time for each entry.
4. Penalties
 - Scrapbooks received after the required deadline will be judged as late entries, and a penalty will be assessed. Students will be penalized five points for one to 15 minutes past the deadline; ten points for 16 to 30 minutes past the deadline; etc.
 - Scrapbooks that do not meet the size requirements as specified in the general rules will be penalized five points.
 - Scrapbooks that contain inappropriate photos will be penalized ten points.
 - Scrapbooks created using online photo sites will not be accepted for judging or display.
 5. For more information on serving as a judge, check out the informative videos on our website here - <https://www.lads2leaders.com/judges-training>

Awards

- First, second, and third place awards will be given in all divisions with three or more entries. **When the number of entries exceeds 12 in any one grade division, finalist awards will also be given.**
- Participants are not eligible to win multiple categories with the same entry.
- The Art Gallery concept that encourages people to view the students' entries has been expanded to allow more time to view the art and reduce the crowd from all being in the room at one time. The room will open after judging is completed. It will remain open for approximately 24 hours. This will allow for more time to view the entries without being rushed.
- Additional signage will be used to make locating the items easier.
- In order for as many people as possible to see the entries, we ask that students leave their artwork in place until close to the posted closing time on Saturday.
- There will be a list of place winners posted in the Art Gallery Room where the entries are displayed. Another list will be posted at the Information Booth.
- Additionally, each of the entries that place in the top three and all finalists will be marked with a small rib-

bon placed on the entries at the conclusion of judging. This will allow those viewing the entries to know which ones placed, as well as giving photo ops with the students and their entries at their convenience. You can share these photos on Instagram or Facebook using the designated hashtag for the year so that we can possibly use them on the screens before the awards ceremonies.

- All award winners will be called to the stage in groups to receive their ribbons and have photo opportunities on stage.

Convention
Event



Winners' Circle Scrapbook

Event Participation

1. Individual – First place winners in the Individual Scrapbook event from previous years.
 - Grades 4-8
 - Grades 9-12
2. Group – First place winners in the Group Scrapbook event from previous years.
3. Participation in Winners' Circle events requires that a student place first at a previous year's L2L Convention. For new convention sites, there will not be a Winners' Circle category the first year, but it will be in place the second year and following.
4. Refer to the Evaluation Forms section of this rulebook to see the forms that will be used by the judges in this event. This will help the student in preparation for the event to see exactly what the judges will be looking for.

Event Rules and Guidelines

All rules for the regular Individual and Group scrapbook event apply.

Awards

First, second, and third place will be recognized with awards in both Individual and Group scrapbook. **When the number of entries exceeds 12 in any one grade division, finalist awards will also be given.**

The Art Gallery and award presentation details on the previous page apply to Winners' Circle Scrapbook.



Song Leading

Purpose

To train young men to fulfill the role of song leaders in the church, since singing is a vital part of the worship service.

Event Participation

1. The Song Leading event will be held on a grade-by-grade basis for grades 3-12. Each student must participate in the academic grade in which he is presently enrolled.
2. Students in Pre-K through grade 2 and Bartimaeus participants may lead but will not be judged.
3. Lesson 8 of the *Field Book of Leadership: Revised* provides basic instruction on Song Leading. The *Field Book of Leadership: Revised* may be ordered by calling the National Service Center or by shopping in our online store. It is very important that participants, parents, coaches, and judges watch the Event Training and Judging Videos on the L2L website under the Convention tab.

Event Rules and Guidelines

1. Boys will be allowed to use a songbook of the leader's choice or song sheets. Be sure to bring copies of the words and music to aid in participation if you are not using a songbook. If using a songbook, bring extra copies to aid in audience participation. Song leaders are responsible for providing their own books. If you choose to make copies, please ensure that all copyright requirements are followed. Unauthorized photocopying of music is an infringement of copyright and will not be allowed. L2L judges will not serve as "copyright police" to make sure that they were copied properly. It is up to each group to make sure that all copyright laws are followed. If it is determined that you need a CCLI license, you may contact them at 1-800-234-2446 or visit their website at www.ccli.com. If you bring extra song books for the audience you will not have to get copyright permission.
2. Students will lead TWO verses of ONE song. Medleys – where one verse of two different songs are led – may not be used. It is acceptable to lead a single verse song through twice.
3. The name and number of the song should be announced so that all can hear.
4. The song must be pitched properly and maintenance of pitch will be judged. Handheld electronic devices may be used to pitch songs.
5. Participants should project their voice to fit the room.
6. Proper hand signals must be used.
7. Proper transition from one stanza to the next will be judged.
8. Projecting the thought and meaning of the song will be judged.
9. Personal appearance is important. This includes not only appropriate dress, but also posture, poise, and neatness.
10. Rules regarding identification of participants:
 - Participants shall not be introduced by name of congregation.
 - Participants will draw a number for the order in which they will lead. The number each participant draws shall be his identification. The judges should not know the participants' names, home congregations, or even geographical origin. Any self-identification by the student, including apparel, shall be penalized three points.
11. A Finalist is defined as a student who leads his song a second time during a second/final round. If a grade uses only one room, and does not break out into a second room, there will be NO FINALISTS for that grade. Only the top three students will be called by name to the stage during the awards ceremony. When two rooms are used for a grade, the top three students in each room will come together again to lead their song a second time in the second/final round. These students are FINALISTS and should proceed to the stage when finalists for that grade are called.

12. Refer to the Evaluation Forms section of this rulebook to see the forms that will be used by the judges in this event. This will help the student in preparation for the event to see exactly what the judges will be looking for.
13. More information on this event and others, check out the videos on our website here - <https://www.lads2leaders.com/training-videos>

Judging

1. Each congregation should provide one male judge for each three participants. If less than three students participate, a minimum of one male judge should be provided.
2. Every attempt shall be made to ensure fairness in evaluating the students.
3. Although there are definite standards of good song leading practices, these are all matters of judgment as one attempts to score another's performance.
4. The preliminary round shall have no more than 15 participants.
5. No spectator may enter or leave the audience while a participant is leading a song.
6. An interval of at least one minute shall be allowed between participants.
7. The judges shall not be acquainted with any of the participants, if possible.
8. The judges must use the official Scoring Sheets furnished.
9. The judges shall be at different locations in the room. They should not be recognized or introduced until after the event is completed.
10. Each judge shall render his final decision of all participants without consultation with other judges or any other person. The results of a judge's decision shall be kept confidential.
11. Judges are asked not to give advice or attempt to coach the participants after the event. Please leave this to the students' own coaches. Even if a participant should ask for a list of strengths, weaknesses, etc., please avoid giving such. This is accomplished in Year-Round Song Leading where evaluations and suggestions are given to the participants. Judges change each year, but the standard is set in the training videos. Remind everyone to watch them.

Judges' Instructions for Song Leading

1. Song leading is to be judged on a 1-10 continuum with 10 points being the highest.
2. Judges will rate each participant upon the following criteria:
 - The proper announcing of the song number or title must be distinct where everyone can hear.
 - The participant's neatness and appropriateness of dress, proper poise, and posture while leading song must be evident.
 - The ability of the participant to start the song on the pitch for which the song was written.
 - The ability of the participant to maintain the same pitch.
 - The ability of the participant to project his voice in relation to the size of the room and size of the audience.
 - The awareness and implementation of the proper tempo.
 - The ability of the leader to maintain the established tempo throughout the song (not rushing or dragging).
 - The ability of the leader to execute a smooth transition from one verse to another.
 - The consistent and effective use of the hand signals.
 - Control of the audience throughout the song.
3. For more information on serving as a judge, check out the informative videos on our website here - <https://www.lads2leaders.com/judges-training>

Awards

First, second, and third place in each division will be awarded. Any participant who leads his song more than once will receive a finalist award. There will be only one round (no finalists) if only one participation room is used. All students will receive a participation ribbon in the room when they lead their songs. They are encourage to wear the ribbons so others at convention can congratulate them on having the courage to lead a song in front of strangers at convention.



Winners' Circle Song Leading

Event Participation

1. All first place Song Leading event winners from previous L2L conventions will participate with other first place winners in the following divisions, as long as there is a sufficient number of participants:

Grades 4-6

Grades 7-9

Grades 10-12

2. Participation in Winners' Circle events requires that a student place first at a previous year's L2L convention. For new convention sites, there will not be a Winners' Circle category the first year, but it will be in place the second year and following.
3. Lesson 8 of the *Field Book of Leadership: Revised* provides basic instruction on Song Leading. The *Field Book of Leadership: Revised* may be ordered by calling the National Service Center or by shopping in our online store. It is very important that participants, parents, coaches, and judges watch the Event Training and Judging Videos on the L2L website under the Convention tab.

For convention locations with multiple color divisions, there may be a need to combine participants in some or all grade divisions in order to have a sufficient number for participation. See the final convention schedule for room assignments. If after 2-3 years in Winners' Circle, a student is not benefiting from the experience and is getting discouraged, he may return to regular Song Leading.

Event Rules and Guidelines

1. All Song Leading event rules apply to the Winners' Circle event.
2. Participants will not participate in the regular Song Leading event.
3. Grades 4-6 will lead the song of their choice. Grades 7-12 will lead one song of their choice AND lead one song from the list provided below. Participants will draw for song selection.
4. L2L will provide song booklets for all Winners' Circle rooms that contain the songs listed below. The songs will be from the *Songs of Faith and Praise* book.
5. It is important to remember that one of the purposes of Winners' Circle Song Leading is to prepare young men to be able to lead singing even when they are not prepared or without prior notice. Since many of these instances will be where song books are not available, the list below contains many of the "old standards" that most will be able to sing without songbooks. This will help prepare them for these types of situations.
6. Refer to the Evaluation Forms section of this rulebook to see the forms that will be used by the judges in this event. This will help the student in preparation for the event to see exactly what the judges will be looking for.

Winners' Circle Songs

Anywhere with Jesus
Blessed Assurance
Faith is the Victory
He Leadeth Me
I Know that My Redeemer Lives
I Love to Tell the Story
I'll Fly Away

Leaning on the Everlasting Arms
Love Lifted Me
My Hope is Built on Nothing Less
No Tears in Heaven
Send the Light
Sing to Me of Heaven
*Sinners Jesus Will Receive***

The Gloryland Way
To God Be the Glory
Victory in Jesus
When Upon Life's Billows
Wonderful Words of Life
Years I Spent in Vanity

** Also called Christ Receiveth Sinful Men

Awards

First, second, and third place awards will be given in each division.



Songs of Praise

Purpose

To encourage girls to prepare themselves to lead women in song in ladies' classes, devotionals, retreats, etc. It is not the intention of L2L to promote or encourage women in leading singing for mixed groups. The integrity of this purpose must be maintained by the participants, parents, group leaders, and elders of each congregation.

Event Participation

1. The Song Leading event will be held on a grade-by-grade basis for grades 3-12. Each student must participate in the academic grade in which she is presently enrolled.
2. Students in Pre-K through grade 2 and Bartimaeus participants may lead, but will not be rated.
3. Lesson 8 of the *Field Book of Leadership: Revised* provides basic instruction on Song Leading. The *Field Book of Leadership: Revised* may be ordered by calling the National Service Center or by shopping in our online store. It is very important that participants, parents, coaches, and judges watch the Event Training and Judging Videos on the L2L website under the Convention tab.

Event Rules and Guidelines

1. Girls will be allowed to use a songbook of the leader's choice or song sheets. Be sure to bring copies of the words and music to aid in participation if you are not using a songbook. If using a songbook, bring extra copies to aid in audience participation. Song leaders are responsible for providing their own books. If you choose to make copies, please ensure that all copyright requirements are followed. Unauthorized photocopying of music is an infringement of copyright and will not be allowed. L2L judges will not serve as "copyright police" to make sure that they were copied properly. It is up to each group to make sure that all copyright laws are followed. If it is determined that you need a CCLI license, you may contact them at 1-800-234-2446 or visit their website at www.ccli.com. If you bring extra song books for the audience you will not have to get copyright permission.
2. Students will lead TWO verses of ONE song. Medleys – where one verse of two different songs are led – may not be used. It is acceptable to lead a single verse song through twice.
3. The name and number of the song should be announced so that all can hear.
4. The song must be pitched and maintenance of pitch will be judged. Handheld electronic devices may be used to pitch songs.
5. Participants should project their voice to fit the room.
6. Proper hand signals must be used.
7. Proper transition from one stanza to the next will be judged.
8. Projecting the thought and meaning of the song will be judged.
9. Personal appearance is important. This includes not only appropriate dress, but also posture, poise, and neatness.
10. Rules regarding identification of participants:
 - Participants will not be introduced by name or congregation.
 - Participants will draw a number for the order in which they will lead. The number each draws shall be her identification. The judges should not know the participants' names, home congregations, or even geographical origin. Any self-identification by the participant, including apparel, shall be penalized three points.
11. A Finalist is defined as a student who leads her song a second time during a second/final round. If a grade uses only one room, and does not break out into a second room, there will be NO FINALISTS for that grade. Only the top three students will be called by name to the stage during the awards ceremony. When two rooms are used for a grade, the top three students in each room will come together again to lead their song a second time in the second/final round. These students are FINALISTS and should proceed to the stage when finalists for that grade are called.

12. No males will be allowed in the rooms where girls are participating in Songs of Praise. See page 94 of this rulebook for more information on this L2L policy. This policy does NOT restrict a mother from bringing her infant or toddler son into a girls' event room.
13. Refer to the Evaluation Forms section of this rulebook to see the forms that will be used by the judges in this event. This will help the student in preparation for the event to see exactly what the judges will be looking for.
14. More information on this event and others, check out the videos on our website here - <https://www.lads2leaders.com/training-videos>

Judging

1. Each congregation should provide one female judge for each three participants. If less than three students participate, a minimum of one female judge should be provided.
2. Every attempt shall be made to ensure fairness in evaluating the participants.
3. Although there are definite standards of good song leading practices, these are all matters of judgment as one attempts to score another's performance.
4. The preliminary round shall have no more than 15 participants.
5. No spectator may enter or leave the audience while a participant is leading a song.
6. An interval of at least a minute shall be allowed between participants.
7. The judges shall not be acquainted with any of the participants, if possible.
8. The judges must use the official Scoring Sheets furnished.
9. The judges shall be at different locations in the room. They should not be recognized or introduced until after the event is completed.
10. Each judge shall render her final decision of all participants without consultation with other judges or any other person. The result of a judge's decision shall be kept confidential.
11. Judges are asked not to give advice or attempt to coach the participants after the event. Please leave this to the students' own coaches. Even if a student should ask for a list of strengths and weaknesses, etc., please avoid giving such. This is accomplished in Year-Round Songs of Praise where evaluations and suggestions are given to the participants. Judges change each year, but the standard is set in the training videos. Remind everyone to watch them.

Judges' Instructions for Songs of Praise

1. Song leading is to be judged on a 1-10 continuum with 10 points being the highest.
2. Judges will rate each participant upon the following criteria:
 - The proper announcing of the song number or title must be distinct where everyone can hear.
 - The participant's neatness and appropriateness of dress, proper poise, and posture while leading song must be evident.
 - The ability of the participant to start the song on the pitch for which the song was written.
 - The ability of the participant to maintain the same pitch.
 - The ability of the participant to project her voice in relation to the size of the room and size of the audience.
 - The awareness and implementation of the proper tempo.
 - The ability of the leader to maintain the established tempo throughout the song (not rushing or dragging).
 - The ability of the leader to execute a smooth transition from one verse to another.
 - The consistent and effective use of the hand signals.
 - Control of the audience throughout the song.
3. For more information on serving as a judge, check out the informative videos on our website here - <https://www.lads2leaders.com/judges-training>

Awards

First, second, and third place will be awarded in each division. Any participant who leads her song more than once will receive a finalist award. There will be only one round (no finalists) if only one participation room is used. All students will receive a participation ribbon in the room when they lead their songs. They are encouraged to wear the ribbons so others at convention can congratulate them on having the courage lead a song in front of strangers at convention.

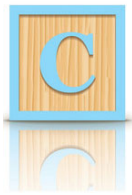

Winners' Circle Songs of Praise

Event Participation

1. All first place Songs of Praise event winners from previous L2L conventions will participate with other first place winners in the following divisions, as long as there is a sufficient number of participants:

Grades 4-6

Grades 7-9

Grades 10-12

2. Participation in Winners' Circle events requires that a student place first at a previous year's L2L convention. For new convention sites, there will not be a Winners' Circle category the first year, but it will be in place the second year and following.
3. Lesson 8 of the *Field Book of Leadership: Revised* provides basic instruction on Song Leading. The *Field Book of Leadership: Revised* may be ordered by calling the National Service Center or by shopping in our online store. It is very important that participants, parents, coaches, and judges watch the Event Training and Judging Videos on the L2L website under the Convention tab.

For convention locations with multiple color divisions, there may be a need to combine participants in some or all grade divisions in order to have a sufficient number for participation. See the final convention schedule for room assignments. If after 2-3 years in Winners' Circle, a student is not benefiting from the experience and is getting discouraged, she may return to regular Songs of Praise.

Event Rules and Guidelines

1. All Songs of Praise event rules apply to the Winners' Circle event. Participants will not participate in the regular Songs of Praise event.
2. Grades 4-6 will lead the song of their choice. Grades 7-12 will lead one song of their choice **AND** lead one song from the list of songs provided below. Participants will draw for song selection.
3. No males will be allowed in the rooms where girls are participating in Winners' Circle Songs of Praise. See page 94 of this rulebook for more information on this L2L policy. This policy does NOT restrict a mother from bringing her infant or toddler son into a girls' event room.
4. L2L will provide song booklets for all Winners' Circle rooms that contain the songs listed below. The songs will be from the *Songs of Faith and Praise* book.
5. It is important to remember that one of the purposes of Winners' Circle Songs of Praise is to prepare young ladies to be able to lead singing in the appropriate settings even when they are not prepared or without prior notice. Since many of these instances will be where song books are not available, the list below contains many of the "old standards" that most will be able to sing without songbooks. This will help prepare them for these types of situations.
6. Refer to the Evaluation Forms section of this rulebook to see the forms that will be used by the judges in this event. This will help the student in preparation for the event to see exactly what the judges will be looking for.

Winners' Circle Songs

Anywhere with Jesus
Blessed Assurance
Faith is the Victory
He Leadeth Me
I Know that My Redeemer Lives
I Love to Tell the Story
I'll Fly Away

Leaning on the Everlasting Arms
Love Lifted Me
My Hope is Built on Nothing Less
No Tears in Heaven
Send the Light
Sing to Me of Heaven
*Sinners Jesus Will Receive***

**** Also called** Christ Receiveth Sinful Men

The Gloryland Way
To God Be the Glory
Victory in Jesus
When Upon Life's Billows
Wonderful Words of Life
Years I Spent in Vanity

Awards

First, second, and third place awards will be given in each division.

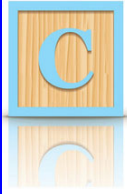

Speech

Purpose

To provide a challenge to students to excel in public speaking and encourage high standards in speech content, organization and delivery. Public speaking is one of the greatest fears among Americans. It is proven that if a person learns to speak in public before they learn to fear it, then they will carry the talent with them for the rest of their life. Public speaking is a talent that will propel all professions and walks of life. Through participation in this event, the students will learn to demonstrate the simple elegance of persuasive speech without the aid of modern technologies.

Event Participation

1. The Speech event will be held on a grade-by-grade basis for grades 3-12. Each student must participate in the academic grade in which he/she is presently enrolled.
2. Students in Pre-K through second grade are given the opportunity to speak, although they will not be rated.
3. While not required, participation in Year-Round Speech provides valuable experience.
4. All students should study the *L2L Speech & Debate* book and lessons 4 & 5 in the *Field Book of Leadership: Revised* to develop their public speaking skills. Both may be ordered by calling the National Service Center or by shopping in our online store. It is very important that participants, parents, coaches, and judges watch the Event Training and Judging Videos on the L2L website under the Convention tab.

Event Rules and Guidelines

1. The speech shall be related to the current year's convention theme. The speech does not have to specifically quote the theme.
2. Speeches are to be viewed as Bible lessons or short sermons. As such, costumes, excessive props, and overly dramatized presentations (screaming, crying, etc.) are unnecessary and will detract from the message. Please strive to maintain the focus of the speeches on a biblical message related to the annual convention theme and not the acting abilities of the speaker.
3. Participants may receive help in the preparation of their speech. Since one of the goals of participating in Speech is to learn how to research and write speeches, the amount of adult help should decrease as the student gets older. Review of the speech and suggestions by parents or mentors is a part of the process, but the students should do progressively more work on the speeches as they grow through the program.
4. Time Limits and Penalties
 - Speeches will be three to five minutes in length for grades 3-6. Speeches will be four and one-half to six minutes in length for grades 7-12.
 - Participants going over or under the time limit will not be cautioned, but will be penalized two points for one to 30 seconds over or under; four points for 31 to 60 seconds over or under; etc.
 - Students reading entirely from a script will be penalized five points.
5. Identification of Participants
 - Participants shall not be introduced by name or by congregation.
 - Each participant will draw a number for the position in which he or she will speak. The number drawn shall be his or her identification. The participant's name, home congregation, and even geographical origins should not be known to the judges. Any self-identification by the participants, including apparel, shall be penalized three points.
6. A Finalist is defined as a student who gives his/her speech a second time during a second/final round. If a grade

uses only one room, and does not break out into a second room, there will be NO FINALISTS for that grade. Only the top three students will be called by name to the stage during the awards ceremony. When two rooms are used for a grade, the top three students in each room will come together again to give their speeches a second time in the second/final round. These students are FINALISTS and should proceed to the stage when finalists for that grade are called.

7. The use of electronic handheld reading devices is allowed for the purpose of reading scripture and/or lesson notes ONLY. The sound must be turned off. The use of other modern technologies, such as, but not limited to, computers, projectors, CD players, etc. will not be allowed.
8. A written copy of the speech does NOT have to be turned in at the time the speech is presented.
9. No males will be allowed in the rooms where girls are participating in Speech. See page 94 of this rulebook for more information on this L2L policy.
10. Refer to the Evaluation Forms section of this rulebook to see the forms that will be used by the judges in this event. This will help the student in preparation for the event to see exactly what the judges will be looking for.
11. More information on this event and others, check out the videos on our website here - <https://www.lads2leaders.com/training-videos>

Judging

1. Judges should be familiar with all of the event rules.
2. Each group must provide one judge for every three participants. (If less than three speakers, a minimum of one judge must be provided.) Please register your judges along with your participants. Please make sure to register the appropriate number of female judges for the number of girls registered for speech and the appropriate number of male judges for the number of boys registered for speech.
3. Every attempt shall be made to ensure fairness in evaluating the event.
4. Although there are definite standards of good oratory and clear principles regarding content, organization, and delivery, these are all matters of value judgment as one attempts to score another's performance.
5. Other Guidelines
 - The primary round shall not have more than 12 participants per room.
 - No spectator may enter or leave the audience while a participant is speaking. The audience should be alerted to this rule before the event begins.
 - An interval of at least one minute shall be allowed between participants.
 - The judges shall not be acquainted with any of the participants, if possible.
 - The judges must use the Official Score Sheets furnished.
 - The judges shall be at different locations in the room. They should not be recognized or introduced until after the event is completed.
 - Each judge shall render his or her final decision on all participants without consultation with other judges or any other person.
 - The results of the judges' decisions shall be kept confidential.
 - Judges are asked not to give advice or attempt to coach the participants after the event. Please leave this to the students' own coaches. Even if a participant should ask for a list of strengths or weaknesses, etc., please avoid giving such. This is accomplished in Year-Round Song Leading where evaluations and suggestions are given to the participants. Judges change each year, but the standard is set in the training videos. Remind everyone to watch them.
 - Applause is in order after all speakers have finished presenting their speeches. The applause simply says, "We appreciate you and the good efforts you have put forth."
 - Boys and girls speech events are held separately. No males will be allowed as spectators in the girls speech event at convention. See page 94 of this rulebook for more information on this L2L Policy. This policy does NOT restrict a mother from bringing her infant or toddler son into a girls' event room.
6. For more information on serving as a judge, check out the informative videos on our website here - <https://www.lads2leaders.com/judges-training>

Judges' Instructions for Speech and Winners' Circle Speech

Participants may receive help in the preparation of their speech. The speech, Convention theme, and the material should receive equitable point value. The scoring has been divided into four phases.

The general intent of each phase is as follows:

PERSONAL QUALITIES – 20 POINTS

1. Poise – Does the speaker have command of self and of the materials? Is the speaker under control?
2. Personality – Does the speaker appear prideful or haughty? Humble? Is the tone warm and friendly?
3. Appearance – Is dress appropriate/modest? Is the speaker neat, clean, and well-groomed?
4. Attitude – Does the speaker act like he or she desires to be in the event, or is made to participate; command the respect of the audience; or speak “to” people or “at” people? Caution: Don’t judge on the externals alone. Be careful with response based on theatrics or emotion alone.

MATERIAL ORGANIZATION – 30 POINTS

1. Biblical Truths – Is the speech scripturally sound? Are scriptures used or referenced?
2. Adherence to Theme – Does the content of the speech relate to the convention theme? (The actual theme phrase itself does not have to be used.) Or does the speaker use the theme phrase occasionally, while the speech has no relation to the theme subject?
3. Value – Is the content a relevant/important message? Is the content appropriate to the speaker’s age level?
4. Logic – Does the speech present a rational thought process, sequential order to the speech?

DELIVERY AND PRESENTATION – 30 POINTS

1. Voice – Does the speaker project well? Is the speaker’s volume too high or too low?
2. Enunciation – Are the speaker’s words clear? Does the speaker avoid colloquial slurs (thang vs. thing)? Does the speaker emphasize proper syllables? Are d’s, t’s, n’s, and ing’s left off the end of words?
3. Pronunciation – Are the speaker’s words distinct? Does the speaker observe the rules of proper grammar? Does he or she pause for commas, stop at periods, etc.?
4. Sincerity – Does the speaker feel his or her message? Is the speech personally owned? Is the speech appropriate to the age level? Does the speaker maintain eye contact with the audience?

OVERALL EFFECTIVENESS – 20 POINTS

1. Appeal – Has the speaker communicated in such a way as to create understanding for his or her subject? Does the conclusion cause the audience to desire to own the message?
2. Impression – Does the speaker accomplish his or her purpose? Does the content of the message fit the presentation? (Speaker’s personality, gestures, delivery, etc.)
3. Effect – Did the speaker’s message and presentation move the audience to action? Did the audience form a conclusion, opinion, etc. based on the speaker’s message and presentation?
4. Knowledge of Material – Did the speaker show a confidence that implied his/her in-depth knowledge of the subject of the speech? This helps to show how much the student was involved in writing the speech and/or how much the student practiced the presentation of the speech.

Awards

First, second, and third place awards will be given for each grade division of participation for both boys and girls. Any participant who is asked to give his/her speech more than once will receive a finalist award. There will be only one round (no finalists) if only one participation room is assigned and/or used. All students will receive a participation ribbon in the room when they give their speeches. They are encourage to wear the ribbons so others at convention can congratulate them on having the courage to give a speech in front of strangers at convention.



Winners' Circle Speech

Purpose

To provide a challenge to high achievers. Through participation in this event, students participate with the best of their age group.

Event Participation

1. Grades 4-12 are involved in the Winners' Circle Speech event.
2. All first place speech winners from all previous L2L Conventions will participate with other first place winners in the following divisions:
Grades 4-6 Grades 7-9 Grades 10-12
3. **In addition to their prepared speeches, participants in grades 10-12 will also draw a topic and present a 1.5-3 minute impromptu/extemporaneous speech. The topics will be chosen from the following chapters from the current year's Pearls Study Guide, *Building Godly Homes*, which may be purchased online at www.lads2leaders.com or by calling 334-215-0251.**

Chapter 2 - When Discouragement Comes to the Home by Aubrey Johnson

Chapter 5 - Qualities of a Godly Youth by Corey Waddell

Chapter 6 - Living in the World, Not of the World by Ben Hayes

Students will be awarded from 0-20 points based on their understanding and effective presentation of their selected topic. These points will be added to the score from the prepared speeches.

Procedures for impromptu/extemporaneous speeches:

After all participants in the room have presented their prepared speeches, and the judges have finished going over the evaluation sheets, all participants will go into the hallway outside the event room with one of the judges. They should line up in the same order as their first speeches. The first participant will draw a topic and **have three minutes to make notes on an index card that they will be given at that time** to prepare for presenting the impromptu speech. They may use their Bibles (printed or electronic) during this time of preparation. It is allowable for participants to use a tablet or other electronic device for looking up scripture for their speeches. At no time, should they be sending or receiving text or email messages. Students should not have pre-written speeches for this part of the event. Remember, notes prepared before-hand will NOT be allowed when the impromptu speech is being given.

In an effort to have the impromptu speech portion of grades 10-12 Winners' Circle Speech truly be impromptu, we will no longer allow any prepared notes to be brought to the Winners' Circle Speech room. This ONLY applies to the impromptu speeches. Students may still have notes as needed for their prepared speeches. We encourage the students to study the assigned chapters of the Pearls book and be ready to make notes during their three-minute preparation time before presenting their impromptu speeches. Students will be given a note card at the start of their preparation time when they receive their topic. They may make any notes they like on that card, but they may not use any previously prepared notes at this time. Students may use their Bible (printed or electronic), but they will be monitored to make sure that they do not look at any prepared notes. For their impromptu speech presentations, they may only bring the note card given to them for this purpose and their Bible (printed or electronic) to the front with them.

When participant one enters the room to present his/her speech, number two will draw a topic and begin preparation. During the speech, the judge in the room that is keeping time will give visual notifications of time remaining starting at two minutes and then each 30 seconds after that. When time is called at the end of three minutes, the participant may finish the sentence that they are on but must stop after that. Number one will exit the room and number two will enter to present his/her speech. Number three will draw a topic and begin preparation. This process will continue until all participants have presented their impromptu/extemporaneous speeches.

Specific to the impromptu/extemporaneous speeches, there will be a 5 point time penalty for being under the 1.5 minute minimum. This penalty will be subtracted from the points assigned for the impromptu/extemporaneous speech. This point total will then be added to the score of the prepared speech.

4. Participation in Winners' Circle events requires that a student place first at a previous year's L2L convention. For new convention sites, there will not be a Winners' Circle category the first year, but it will be in place the second year and following.
5. Winners' Circle participants will not participate in the regular speech event.
6. If after 2-3 years in Winners' Circle, a student is not benefiting from the experience and is getting discouraged, he or she may return to regular Speech.
7. All students should study the *L2L Speech & Debate* book and lessons 4 & 5 in the *Field Book of Leadership: Revised* to develop their public speaking skills. Both may be ordered by calling the National Service Center or by shopping in our online store. It is very important that participants, parents, coaches, and judges watch the Event Training and Judging Videos on the L2L website under the Convention tab.
8. Refer to the Evaluation Forms section of this rulebook to see the forms that will be used by the judges in this event. This will help the student in preparation for the event to see exactly what the judges will be looking for.

Event Rules and Guidelines

All Official Rules for Speech will apply in full to this event.

Awards

First, second, and third place awards will be given in each boys' and girls' division.

For grades 10-12 only, there will not be any Finalists if there are more than 12 participants. Instead, the top three from each room will receive 1st, 2nd, and 3rd place trophies. It will function like Puppet Theater where there would be, for example, Blue and Blue-White divisions rather than having two rounds with Finalists.

Winners' Circle events may or may not run simultaneously with the regular Speech event. **Check the convention schedule for specific information.** For convention locations with multiple color divisions, there may be a need to combine participants in some or all grade divisions in order to have a sufficient number for participation. See the final convention schedule for room assignments.

No males will be allowed in the rooms where girls are participating in Winners' Circle Speech. See the last page of this rulebook for more information on this L2L Policy. This policy does NOT restrict a mother from bringing her infant or toddler son into a girls' event room.

The Reasoning Behind No Males in Girls' Events

From time to time, interested parents and grandparents ask us the reason for our firm policy prohibiting males from attending girls' events at our conventions. People sometimes assume it is because we believe it would be wrong in all instances for males to be present, and that's not actually true.

There are two reasons for our strict policy: First, selecting some circumstances in the many events in which males are permitted and others where they are not, would be difficult (and perhaps impossible) to enforce. Second, and more importantly, it is because we want to train our young people to be sensitive to the gender differences taught in the New Testament for teaching and worship (1 Timothy 2:11-14).

Remember, we are training students distinctively to serve in the church of Christ. Our policy about girls' events, we believe, has been accomplishing this purpose since the inception of L2L. It is important to note that mothers are allowed to bring their sons that are in grade 2 (or 8 years old) or younger into a girls' event room.

Our work is to help train young people to be leaders in their communities and faithful leaders in the church you read about in the New Testament. Thank you for encouraging the young people in your life to enjoy growing with L2L.



Building Godly Leaders

Entry Forms

&

Log Sheets

*Updated for
2023 Convention*

**ART SAYS IT
OFFICIAL ENTRY FORM**

This form must accompany all entries in the Art Says It event when they are submitted at the convention. Do not mail this form. Present it with the artwork or attach it to the back or bottom of the artwork.

Please indicate student's grade division:

3-4 5-6 7-8 9-10 11-12

Please indicate the category entered:

Painting Drawing/Sketching
 Photography Poster (Grades 3-6 only)

Please indicate student's grade division (Bulletin Board ONLY):

3-4 5-6 7-9 10-12
 Bulletin Board

Student Name _____

Group Name _____

Group City, State _____

Group Color _____

© 2022, L2L

**ART SAYS IT
OFFICIAL ENTRY FORM**

This form must accompany all entries in the Art Says It event when they are submitted at the convention. Do not mail this form. Present it with the artwork or attach it to the back or bottom of the artwork.

Please indicate student's grade division:

3-4 5-6 7-8 9-10 11-12

Please indicate the category entered:

Painting Drawing/Sketching
 Photography Poster (Grades 3-6 only)

Please indicate student's grade division (Bulletin Board ONLY):

3-4 5-6 7-9 10-12
 Bulletin Board

Student Name _____

Group Name _____

Group City, State _____

Group Color _____

© 2022, L2L

**ART SAYS IT
OFFICIAL ENTRY FORM**

This form must accompany all entries in the Art Says It event when they are submitted at the convention. Do not mail this form. Present it with the artwork or attach it to the back or bottom of the artwork.

Please indicate student's grade division:

3-4 5-6 7-8 9-10 11-12

Please indicate the category entered:

Painting Drawing/Sketching
 Photography Poster (Grades 3-6 only)

Please indicate student's grade division (Bulletin Board ONLY):

3-4 5-6 7-9 10-12
 Bulletin Board

Student Name _____

Group Name _____

Group City, State _____

Group Color _____

© 2022, L2L

**ART SAYS IT
OFFICIAL ENTRY FORM**

This form must accompany all entries in the Art Says It event when they are submitted at the convention. Do not mail this form. Present it with the artwork or attach it to the back or bottom of the artwork.

Please indicate student's grade division:

3-4 5-6 7-8 9-10 11-12

Please indicate the category entered:

Painting Drawing/Sketching
 Photography Poster (Grades 3-6 only)

Please indicate student's grade division (Bulletin Board ONLY):

3-4 5-6 7-9 10-12
 Bulletin Board

Student Name _____

Group Name _____

Group City, State _____

Group Color _____

© 2022, L2L

Year-Round Bible Reading/Study Verification Form

Student's Name _____ Grade _____

Group Name _____

City _____ State _____

This is to certify that the following qualifications have been successfully completed and verified by an adult.

Participant has read scripture to the congregation, youth group, Bible class or ladies class: Yes No

Participant has read scripture to the sick, disabled, bereaved or younger children: Yes No

Participant was able to find and read aloud the Plan of Salvation: Yes No

Participant read a complete chapter of the Bible to an audience: Yes No

Participant successfully completed Public Speaking Technique/Microphone Training (Lesson 5, *Field Book of Leadership: Revised*): Yes No

Signature of Student

Signature of Verifying Adult

_____ Date _____

This verification form is to be given to your team leader prior to the registration deadline. **DO NOT MAIL ANYTHING TO THE NATIONAL SERVICE CENTER.**

© 2022, L2L

**CENTURION OF SCRIPTURE OFFICIAL
VERIFICATION FORM**

Participant's Name _____

Participant's Age _____

Group Name _____

City _____ State _____

Signature of verifying adult

SINGLE CENTURION

Mark the appropriate box and list the verses on the chart provided.

- Bronze award: 100 Scriptures in any number of recitations.
- Silver award: 100 Scriptures in two recitations of 50 verses each.
- Gold award: 100 Scriptures quoted in one recitation.

MULTIPLE CENTURIONS

Please give the number for each award successfully completed this year. List the verses on the chart provided. There must be a different list for each award earned.

Bronze award: Qty. _____

Silver award: Qty. _____

Gold award: Qty. _____

DECA CENTURIONS

Please complete for each time you earned ten centurion awards during the previous ten years or less. List the awards earned and the year awarded. (i.e., Gold 2007, Silver & Bronze 2008, etc.).

This verification form is to be given to your team leader prior to the registration deadline. **DO NOT MAIL ANYTHING TO THE NATIONAL SERVICE CENTER.**

**CENTURION OF SCRIPTURE OFFICIAL
VERIFICATION FORM**

Participant's Name _____

Participant's Age _____

Group Name _____

City _____ State _____

Signature of verifying adult

SINGLE CENTURION

Mark the appropriate box and list the verses on the chart provided.

- Bronze award: 100 Scriptures in any number of recitations.
- Silver award: 100 Scriptures in two recitations of 50 verses each.
- Gold award: 100 Scriptures quoted in one recitation.

MULTIPLE CENTURIONS

Please give the number for each award successfully completed this year. List the verses on the chart provided. There must be a different list for each award earned.

Bronze award: Qty. _____

Silver award: Qty. _____

Gold award: Qty. _____

DECA CENTURIONS

Please complete for each time you earned ten centurion awards during the previous ten years or less. List the awards earned and the year awarded. (i.e., Gold 2007, Silver & Bronze 2008, etc.).

This verification form is to be given to your team leader prior to the registration deadline. **DO NOT MAIL ANYTHING TO THE NATIONAL SERVICE CENTER.**

GIFTS Verification Form

Church Name/City/State _____

Name _____ Grade _____

Name _____ Grade _____

Name _____ Grade _____

Name _____ Grade _____

Name _____ Grade _____

Name _____ Grade _____

Name _____ Grade _____

Name _____ Grade _____

Name _____ Grade _____

Name _____ Grade _____

This verification form is to be given to your team leader prior to the registration deadline. It does NOT have to be mailed to the National Service Center.

_____ **Students listed above have attended classes for all chapters of the GIFTS book and have completed the minimum six (6) projects from the GIFTS book.**

Signature of verifying adult: _____

Date: _____

GUARD Verification Form

Church Name/City/State _____

Name _____ Grade _____

Name _____ Grade _____

Name _____ Grade _____

Name _____ Grade _____

Name _____ Grade _____

Name _____ Grade _____

Name _____ Grade _____

Name _____ Grade _____

Name _____ Grade _____

Name _____ Grade _____

This verification form is to be given to your team leader prior to the registration deadline. It does NOT have to be mailed to the National Service Center.

_____ **Students listed above have attended classes for all chapters of the GUARD book and have completed the minimum six (6) projects from the GUARD book.**

Signature of verifying adult: _____

Date: _____

Junior Leader Verification Form

Church Name _____

City/ State _____

The following students have completed all three levels of Junior Leader. Level One, Two and Three Certificates for Junior Leader were sent with the student books when they were ordered.

There is no official deadline for this form because it is not a convention event. However, in order to include the students' names in the convention program, they must be registered by the posted registration deadline.

Name	Grade	Level Completed

INDIVIDUAL OR GROUP SCRAPBOOK

OFFICIAL ENTRY FORM

All entries of individuals or groups in the Scrapbook event must be accompanied by this form when they are submitted at convention.

Please indicate the event you are entering:

- Individual Scrapbook
- Group Scrapbook

INDIVIDUAL ENTRY

Please indicate the student's grade division:

- 3-6 7-9 10-12

Student Name _____

Group Name _____

Group City, State _____

Group Color Division (Red, Blue, etc.) _____

GROUP ENTRY

Group Name _____

Group City, State _____

Group Color Division (Red, Blue, etc.) _____

INDIVIDUAL OR GROUP SCRAPBOOK

OFFICIAL ENTRY FORM

All entries of individuals or groups in the Scrapbook event must be accompanied by this form when they are submitted at convention.

Please indicate the event you are entering:

- Individual Scrapbook
- Group Scrapbook

INDIVIDUAL ENTRY

Please indicate the student's grade division:

- 3-6 7-9 10-12

Student Name _____

Group Name _____

Group City, State _____

Group Color Division (Red, Blue, etc.) _____

GROUP ENTRY

Group Name _____

Group City, State _____

Group Color Division (Red, Blue, etc.) _____

INDIVIDUAL OR GROUP WINNERS' CIRCLE

SCRAPBOOK OFFICIAL ENTRY FORM

All entries of individuals or groups in the Scrapbook event must be accompanied by this form when they are submitted at convention.

Please indicate the event you are entering:

- Individual Scrapbook
- Group Scrapbook

Please indicate the year in which your scrapbook placed first in an L2L Scrapbook event:

Year _____

Grade (for Individual) _____

INDIVIDUAL ENTRY

Please indicate the student's grade division:

- 4-8 9-12

Student Name _____

Group Name _____

Group City, State _____

Group Color Division (Red, Blue, etc.) _____

GROUP ENTRY

Group Name _____

Group City, State _____

Group Color Division (Red, Blue, etc.) _____

INDIVIDUAL OR GROUP WINNERS' CIRCLE

SCRAPBOOK OFFICIAL ENTRY FORM

All entries of individuals or groups in the Scrapbook event must be accompanied by this form when they are submitted at convention.

Please indicate the event you are entering:

- Individual Scrapbook
- Group Scrapbook

Please indicate the year in which your scrapbook placed first in an L2L Scrapbook event:

Year _____

Grade (for Individual) _____

INDIVIDUAL ENTRY

Please indicate the student's grade division:

- 4-8 9-12

Student Name _____

Group Name _____

Group City, State _____

Group Color Division (Red, Blue, etc.) _____

GROUP ENTRY

Group Name _____

Group City, State _____

Group Color Division (Red, Blue, etc.) _____

Second Language Verification Form

Church Name/City/State _____

Name _____

Grade _____ Sex _____

This verification form is to be given to your team leader prior to the registration deadline. It does NOT have to be mailed to the National Service Center.

_____ **BRONZE LEVEL** – The student listed above has completed the requirements for the Bronze level of the Second Language event. Log sheet(s) are attached.

Language(s) used _____

_____ **SILVER LEVEL** – The student listed above has completed the requirements for the Silver level of the Second Language event. Log sheet(s) are attached.

Language(s) used _____

_____ **GOLD LEVEL** – The student listed above has completed the requirements for the Gold level of the Second Language event. Log sheet(s) are attached.

Language(s) used _____

Signature of verifying adult: _____

Date: _____

Sower Verification Form

Church Name/City/State _____

Participant's Name _____

Grade (List A if adult) _____ Gender _____

This verification form is to be given to your team leader prior to the registration deadline. It does NOT have to be mailed to the L2L National Service Center. It is for local records only.

The participant named above has completed all requirements stated in the rules section for the Sower event.

Signature of Verifying Adult: _____

Date: _____

Year-Round Speech Final Checklist

Checklist

Completed

1. Minimum of three speeches given at least one time each for
a minimum of 12 total presentations.

2. One set of speeches in file folder (can be electronic)

****Do not send speeches to the National Office****

3. Evaluation Forms & Speech Log were completed

****DO NOT MAIL ANYTHING TO THE NATIONAL SERVICE CENTER.****

I am verifying and agree that _____ from

(Name of Student)

_____ has completed all requirements for

(Congregation/City/State)

Year-Round Speech and has earned a _____ award.

(Bronze, Silver, Gold)

Verifying Adult: _____

Printed Name: _____

Title: _____

*It is the adult's responsibility to ensure that
honesty and integrity are maintained in this
event.*

Year-Round Song Leading Verification Form

Church Name/City/State _____

Name _____

Grade _____

All work for this event is done locally. Keep all information for the student's records. Registration must be completed and verified in the online registration system by the registration deadline.

****DO NOT MAIL ANYTHING TO THE NATIONAL SERVICE CENTER.****

Checklist for verification:

1. 3 songs led at least two times each for a minimum of 12 songs led.
4 songs led at least two times each for a minimum of 18 songs led.
5 songs led at least two times each for a minimum of 24 songs led.
2. Log (including dates, titles, places, audiences, and adult signature)
3. Evaluators' sheets (at least 2 – initial and final)

I am verifying and agree that _____ from

(Name of Student)

_____ has completed all requirements for

(Congregation/ City/State)

Year-Round Song Leading and has earned a _____ award.

(Bronze, Silver, Gold)

Verifying Adult: _____

Printed Name: _____

Title: _____

*It is the adult's responsibility to ensure that
honesty and integrity are maintained in this
event.*

Year-Round Songs of Praise

Verification Form

Church Name/City/State _____

Name _____

Grade _____

All work for this event is done locally. Keep all information for the student's records. Registration must be completed and verified in the online registration system by the registration deadline.

DO NOT MAIL ANYTHING TO THE NATIONAL SERVICE CENTER.*

Checklist for verification:

1. 3 songs led at least two times each for a minimum of 10 songs led.
4 songs led at least two times each for a minimum of 15 songs led.
5 songs led at least two times each for a minimum of 20 songs led.
2. Log (including dates, titles, places, audiences, and adult signature)
3. Evaluators' sheets (at least 2 – initial and final)

I am verifying and agree that _____ from
(Name of Student)

_____ has completed all requirements for
(Congregation/ City/State)

Year-Round Songs of Praise and has earned a _____ award.
(Bronze, Silver, Gold)

Verifying Adult: _____

Printed Name: _____

Title: _____

It is the adult's responsibility to ensure that
honesty and integrity are maintained in this
event.



Building Godly Leaders

Evaluation Forms

*Updated for
2023 Convention*

Art Says It Evaluation

Rate each evaluation on a scale of 1 to 5

1 = Poor; 2 = Fair; 3 = Good; 4 = Excellent; 5 = Superior

Category _____

Grade Division _____

Team Color _____

NOTE: To be fair to all participants, score the first entry at a point where the others can be scored higher or lower.

Entries												
Items to be Judged	A	B	C	D	E	F	G	H	I	J	K	L
Construction/Composition												
Use of Materials or Lighting/Surroundings												
Quality of Work												
Subtotal												
Content												
Clearly Expresses Message												
Convention Theme Presentation												
Subtotal												
Creativity												
Originality												
Design/Layout												
Overall Appeal												
Subtotal												
Penalties												
Self-identification - all categories except Bulletin Board (-3 points)												
Entry Framed and/or Matted (-5 points)												
Over/Under Size Requirements (-5 points)												
Improper Use of a Copyrighted Figure (-10 points)												
Grand Total												
Ranking*												

* Ranking: After scoring all entries, indicate their ranking based on your scoring. The highest score will be 1, the next will be 2, etc. The coordinator will use these rankings to determine the award winners.

Banner Evaluation

Rate each evaluation on a scale of 1 to 25 (1 = Poor; 25 = Superior)

Banners MUST display the Lads to Leaders/Leaderettes name OR the Flying L logo or be disqualified.

Team Color _____

NOTE: To be fair to all participants, score the first entry at a point where the others can be scored higher or lower.

Group	1	2	3	4	5	6	7	8	9	10	11	12
Content												
Effectively expresses team personality												
Creativity												
Originality, Materials, Uniqueness												
Construction												
Detail, Layout, Composition												
Penalties												
Exceeded size (-10 points)												
No Group Identification (-15 points)												
Late Entry (-10 points)												
No Copyright Authorization (-10 points)												
Grand Total												
Ranking*												

Group	13	14	15	16	17	18	19	20	21	22	23	24
Content												
Effectively expresses team personality												
Creativity												
Originality, Materials, Uniqueness												
Construction												
Detail, Layout, Composition												
Penalties												
Exceeded size (-10 points)												
No Group Identification (-15 points)												
Late Entry (-10 points)												
No Copyright Authorization (-10 points)												
Grand Total												
Ranking*												

* Ranking: After scoring all entries, indicate their ranking based on your scoring. The highest score will be 1, the next will be 2, etc. The coordinator will use these rankings to determine the award winners.

ORAL BIBLE READING RATING SHEET

The readings may be taken from either the Old or New Testament. Points may be accumulated as indicated below, and ratings are to be determined based upon the total number of points. Participants are to be judged by grade division. One judge should serve for each grade. The completed rating sheet is to be given to the participant in order that he/she might know in which areas to improve.

Time:_____ 1. Reading may not be less than one minute nor more than two minutes. Students will be penalized one point for 1 to 30 seconds under one minute or over two minutes; two points for 31 to 60 seconds under one minute or over two minutes; etc.

Circle points given in each category:

(3) (2) (1) 2. Appearance (neat and appropriate)

(3) (2) (1) 3. Poise and Posture

(3) (2) (1) 4. Voice and Articulation

(3) (2) (1) 5. Effectiveness in identification of passage and translation

(3) (2) (1) 6. Appropriate volume for the room used

Point Scale: (3) = Excellent (2) = Good (1) = Needs Improvement

Ratings: AAA = 14-15 points

AA = 11-13 points

A = 10 points and below

Name of Participant _____

Grade _____

Total Points _____

Rating _____

DEBATE SCORE SHEET

Round _____ Room _____

Side: Affirmative Negative

Score 1 to 10 points in each category. Scale: 1-2 = Poor; 3-4 = Fair; 5-6 = Good; 7-8 = Excellent; 9-10 = Superior

First Speaker's Name _____

Second Speaker's Name _____

		Points for First Speaker	Points for Second Speaker
Analysis & Case:	Effective overall strategy	_____	_____
	Topical (Affirmative)		
	Responsive (Negative)		
Rebuttal:	Adaptation & Attack	_____	_____
	Defense of own case		
Organization:	Easy to follow	_____	_____
	Logically put together		
Evidence:	Sufficient	_____	_____
	Dependable		
Delivery:	Easily Understood	_____	_____
	Direct, Courteous		
	SUBTOTAL	_____	_____
Penalties:	New issues presented in rebuttal speeches (-1 per issue)	_____	_____
	Over time limit (-1 for each 30 seconds or fraction thereof)	_____	_____
	TOTAL	_____	_____

DEBATE SUMMARY SCORE SHEET

Round _____

Room _____

Winning team is the: Affirmative Negative

	Points (From Team Score Sheet)
Affirmative Team	
First Speaker's Name _____	_____
Second Speaker's Name _____	_____
Five (5) Point Bonus if Winning Team	_____
Total Team Points	_____

	Points (From Team Score Sheet)
Negative Team	
First Speaker's Name _____	_____
Second Speaker's Name _____	_____
Five (5) Point Bonus if Winning Team	_____
Total Team Points	_____

Score sheets are not to be given to

anyone. © 2022, L2L

Mass Communications - Blogging Evaluation

Grade Division _____

NOTE: To be fair to all participants, score the first entry at a point where the others can be scored higher or lower.

Team Color _____

Entries												
Items to be Judged	A	B	C	D	E	F	G	H	I	J	K	L
Content 20 Points												
Biblical Accuracy; Clarity or Principle Presented												
Adherence to Theme 15 Points												
Composition 25 Points												
Introduction; Development of Thought; Conclusion or Summary												
Grammar, Syntax & Vocabulary 20 Points												
Actual Use of Language												
Reader Appeal 20 Points												
Creativity; Timeliness; Continuity of Thought												
Subtotal												
Penalties												
Self-identification (-3 points)												
Word Infraction (-2 per 25 words over or under)												
Grand Total												

Mass Communications - Podcasting Evaluation

Grade Division _____

NOTE: To be fair to all participants, score the first entry at a point where the others can be scored higher or lower.

Team Color _____

Entries												
Items to be Judged	A	B	C	D	E	F	G	H	I	J	K	L
Content 20 Points												
Adherence to Theme; Clarity of Principle Presented; Biblical Accuracy												
Information and Structure 30 Points												
Engaging; Organized; Easy to follow												
Personality and Creativity 30 Points												
Does it have personality and make you feel something?												
Production 20 Points												
Quality of sound and recording; Creativity												
Subtotal												
Penalties												
Self-identification (-3 points)												
Time Infraction (2 points per 30 seconds over or under)												
Grand Total												

Mass Communications - PowerPoint Evaluation

Grade Division _____

NOTE: To be fair to all participants, score the first entry at a point where the others can be scored higher or lower.

Team Color _____

Entries												
Items to be Judged	A	B	C	D	E	F	G	H	I	J	K	L
Biblical Message 25 Points												
Biblical Accuracy; Clarity of Principle Presented; Adherence to Pearls Chapter												
Scriptures Used 20 Points												
Appearance 20 Points												
Introduction; Development of Thought; Conclusion or Summary												
Creativity 15 Points												
Appropriate Use of Color, Backgrounds, etc.												
Overall Usefulness 20 Points												
Easily Used With Limited Additional Input												
Subtotal												
Penalties												
Copyright Infraction (-5 points)												
Excessive or Distracting Animations (-10 points)												
Over/under 20 slide limit (-5 per page)												
Grand Total												

Mass Communications - Storyline Evaluation

NOTE: To be fair to all participants, score the first entry at a point where the others can be scored higher or lower.

Grade Division _____

Team Color _____

Entries												
Items to be Judged	A	B	C	D	E	F	G	H	I	J	K	L
Content 25 Points												
Biblical Accuracy; Clarity of Principle Presented; Adherence to Theme												
Creativity 15 Points												
Dramatization; Sound Effects; Audience Appeal												
Character Representation 10 Points												
Appearance; Poise; Personality; Attitude												
Costumes 10 Points												
Authenticity; Appearance												
Set 10 Points												
Authenticity; Appearance; Creativity												
Dialogue 10 Points												
Continuity; Transition Between Characters												
Overall Effectiveness 20 Points												
Appeal; Impression; Effect												
Subtotal												
Penalties												
Self-identification (-3 points)												
Time Infraction (-2 points per 10 seconds over/under)												
Grand Total												

Puppet Theater Evaluation

NOTE: To be fair to all participants, score the first entry at a point where others can be scored higher or lower.

Room: _____
 Grade Division: _____
 Team Color: _____

Puppet Teams									
Items to be Judged	Points	A	B	C	D	E	F	G	H
Creativity									
Original Ideas/Script	10								
Costumes and Use of Stage Area	10								
Based on Convention Theme (Clearly Linked to Theme)	10								
Biblical Message	10								
Animation									
Movement of Puppet Mouth Meshed With Dialogue	10								
Positioning of Puppets - Don't Sink or Rise	10								
Entrance and Exit of Puppets Done Smoothly	5								
Sound Quality (Puppets Heard/Understood)	10								
Special Effects (Posters, Sounds, Tapes)	5								
Teamwork (Working Together From Setup to Tear Down)	10								
Overall Effectiveness	10								
Subtotal	100								
Penalties									
Per 30 seconds over 12 minute total	-2								
Per 30 seconds under 5 minutes for skit	-2								
Identification of home congregation	-10								
Per judge if stage not left as found	-2								
Risque or inappropriate language or humor	-10								
Excessive special effects that take away from message	-10								
Grand Total									
Ranking*									

* Ranking: After scoring all entries, indicate their ranking based on your scoring. The highest score will be 1, the next will be 2, etc. The coordinator will use these rankings to determine the award winners.

Individual/Group Scrapbook Evaluation

Grade Division for Individual Entries: _____

NOTE: To be fair to all participants, score the first entry at a point where others can be scored higher or lower.

Team Color: _____

		Entries											
Items to be Judged	Points	A	B	C	D	E	F	G	H	I	J	K	L
Cover Design	1-10												
Table of Contents	1-10												
Introduction/Organization/Composition/Construction	1-20												
Appeal/Impression	1-15												
Creativity	1-15												
Theme (progress throughout year)	1-15												
Conclusion	1-15												
Subtotal	100												
Penalties													
Late Entry: -5 points for every 15 minutes late													
Size: -5 points for not meeting minimum/maximum requirements (8.5"x11" to 14"x18")													
Inappropriate photos: -10 points													
Grand Total													
Ranking*													

* Ranking: After scoring all entries, indicate their ranking based on your scoring. The highest score will be 1, the next will be 2, etc. The coordinator will use these rankings to determine the award winners.

Individual/Group Winners' Circle Scrapbook Evaluation

Grade Division for Individual Entries: _____

NOTE: To be fair to all participants, score the first entry at a point where others can be scored higher or lower.

Team Color: _____

		Entries											
Items to be Judged	Points	A	B	C	D	E	F	G	H	I	J	K	L
Cover Design	1-10												
Table of Contents	1-10												
Introduction/Organization/Composition/Construction	1-20												
Appeal/Impression	1-15												
Creativity	1-15												
Theme (progress throughout year)	1-15												
Conclusion	1-15												
Subtotal	100												
Penalties													
Late Entry: -5 points for every 15 minutes late													
Size: -5 points for not meeting minimum/maximum requirements (8.5"x11" to 14"x18")													
Inappropriate photos: -10 points													
Grand Total													
Ranking*													

* Ranking: After scoring all entries, indicate their ranking based on your scoring. The highest score will be 1, the next will be 2, etc. The coordinator will use these rankings to determine the award winners.

Song Leading Evaluation

Rate each evaluation on a 1 to 10 scale (1 = Poor; 10 = Superior)

Team Color: _____ Room: _____

Grade: _____ 1st Round: _____ Final Round: _____

Remind audience to sing with the same enthusiasm for all participants.

NOTE: To be fair to all participants, score the first entry at a point where others can be scored higher or lower.

Items to be Judged	Participants														
	1	2	3	4	5	6	7	8	9	10	11	12	13	14	15
Announce Number/Title															
Appearance/Poise															
Pitch Awareness															
Maintenance of Pitch															
Voice Projection															
Tempo Awareness															
Maintenance of Tempo															
Transition to Next Verse															
Hand Sign Use Effective															
Leading the Audience															
Subtotal															
Penalties															
Self identification (-3 points)															
Less than or more than two stanzas (-2 points)															
Grand Total															
Ranking*															

* Ranking: After scoring all entries, indicate their ranking based on your scoring. The highest score will be 1, the next will be 2, etc. The coordinator will use these rankings to determine the award winners.

Year-Round Song Leading Evaluation & Feedback Form

Participant Name: _____ Grade _____

Congregation: _____ City/State: _____

Title of Song: _____

Audience: _____

Check one: First Leading _____ Final Leading _____

Items to be Evaluated	Score
Presentation <i>20 points</i> <i>Announce Number, Title, Appearance, Poise</i>	
Pitch <i>20 points</i> <i>Awareness, Maintenance of Pitch</i>	
Voice Projection <i>20 points</i> <i>Voice, Enunciation, Pronunciation, Gestures, Sincerity, Emphasis</i>	
Tempo <i>20 points</i> <i>Awareness, Maintenance of Tempo</i>	
Leading the Audience <i>20 points</i> <i>Hand Sign Use, Transition to Next Verse</i>	
Total	

Rating _____

(Superior: 85-100, Excellent: 70-84, Good: 50-69)

Suggestions: _____

Evaluated By: _____

Printed Name: _____

Date: _____

Songs of Praise Evaluation

Rate each evaluation on a 1 to 10 scale (1 = Poor; 10 = Superior)

Team Color: _____ Room: _____

Grade: _____ 1st Round: _____ Final Round: _____

Remind audience to sing with the same enthusiasm for all participants.

NOTE: To be fair to all participants, score the first entry at a point where others can be scored higher or lower.

Items to be Judged	Participants														
	1	2	3	4	5	6	7	8	9	10	11	12	13	14	15
Announce Number/Title															
Appearance/Poise															
Pitch Awareness															
Maintenance of Pitch															
Voice Projection															
Tempo Awareness															
Maintenance of Tempo															
Transition to Next Verse															
Hand Sign Use Effective															
Leading the Audience															
Subtotal															
Penalties															
Self identification (-3 points)															
Less than or more than two stanzas (-2 points)															
Grand Total															
Ranking*															

* Ranking: After scoring all entries, indicate their ranking based on your scoring. The highest score will be 1, the next will be 2, etc. The coordinator will use these rankings to determine the award winners.

Year-Round Songs of Praise Evaluation & Feedback Form

Participant Name: _____ Grade _____

Congregation: _____ City/State: _____

Title of Song: _____

Audience: _____

Check one: First Leading _____ Final Leading _____

Items to be Evaluated	Score
Presentation <i>20 points</i> <i>Announce Number, Title, Appearance, Poise</i>	
Pitch <i>20 points</i> <i>Awareness, Maintenance of Pitch</i>	
Voice Projection <i>20 points</i> <i>Voice, Enunciation, Pronunciation, Gestures, Sincerity, Emphasis</i>	
Tempo <i>20 points</i> <i>Awareness, Maintenance of Tempo</i>	
Leading the Audience <i>20 points</i> <i>Hand Sign Use, Transition to Next Verse</i>	
Total	

Rating _____

(Superior: 85-100, Excellent: 70-84, Good: 50-69)

Suggestions: _____

Evaluated By: _____

Printed Name: _____

Date: _____

Speech Evaluation

Team Color: _____
 Grade: _____

Room: _____
 1st Round: _____ Final Round: _____

NOTE: To be fair to all participants, score the first entry at a point where others can be scored higher or lower.

Participants												
Items to be Judged	1	2	3	4	5	6	7	8	9	10	11	12
Personal Qualities 20 Points												
Poise, Appearance, Personality, Attitude												
Material/Organizational Quality 30 Points												
Biblical Truths, Adherence to Theme, Value, Logic, Scripture Usage, Flow and Organization												
Delivery and Presentation 30 Points												
Voice, Enunciation, Pronunciation, Gestures, Sincerity, Emphasis, Knowledge of Material												
Overall Effectiveness 20 Points												
Appeal, Impression, Effect												
Subtotal												
Penalties												
Self identification (-3 points)												
Time infraction (-2 points per 30 seconds over or under)												
Reading entirely from script (-5 points)												
Grand Total												
Ranking*												

* Ranking: After scoring all entries, indicate their ranking based on your scoring. The highest score will be 1, the next will be 2, etc. The coordinator will use these rankings to determine the award winners.

Winners' Circle Speech Evaluation

Team Color: _____
Grade: _____

Room: _____

NOTE: To be fair to all participants, score the first entry at a point where others can be scored higher or lower.

Participants												
Items to be Judged	1	2	3	4	5	6	7	8	9	10	11	12
Personal Qualities 20 Points Poise, Appearance, Personality, Attitude												
Material/Organizational Quality 30 Points Biblical Truths, Adherence to Theme, Value, Logic, Scripture Usage, Flow and Organization												
Delivery and Presentation 30 Points Voice, Enunciation, Pronunciation, Gestures, Sincerity, Emphasis, Knowledge of Material												
Overall Effectiveness 20 Points Appeal, Impression, Effect												
Subtotal												
Penalties												
Self identification (-3 points)												
Time infraction (-2 points per 30 seconds over or under)												
Reading entirely from script (-5 points)												
Subtotal after any penalties												
Points for impromptu speech for grades 10-12.. Assign 0-20 points based on how effective the speaker is in conveying his/her understanding of the topic drawn. Penalty: Reduce this point total by 5 points if the speaker is under the 1.5 minute minimum.												
Grand Total												
Ranking*												

* Ranking: After scoring all entries, indicate their ranking based on your scoring. The highest score will be 1, the next will be 2, etc. The coordinator will use these rankings to determine the award winners.

Year-Round Speech Evaluation & Feedback Form

Participant Name: _____ Grade _____

Congregation: _____ City/State: _____

Audience: _____

Check one: First Presentation _____ Final Presentation _____

Items to be Evaluated	Score
Personal Qualities <i>20 points</i> <i>Appearance, Poise, Personality, Attitude</i>	
Material/Organization Quality <i>30 points</i> <i>Biblical Truths, Value, Logic, Scripture Usage, Flow & Organization</i>	
Delivery and Presentation <i>30 points</i> <i>Voice, Enunciation, Pronunciation, Gestures, Sincerity, Emphasis</i>	
Overall Effectiveness <i>20 points</i> <i>Appeal, Impression, Effect</i>	
Total	

Rating _____

(Superior: 85-100, Excellent: 70-84, Good: 50-69)

Suggestions: _____

Evaluated By: _____

Printed Name: _____

Date: _____